

Dead weight tester with OIL



Models : BH2



Models : BH2 + option OP0004



Models: BH4 or BH2 +Option OP0301

Concerns the models :

- ✓ model : BH2-150B
- ✓ model : BH2-300B SP
- ✓ model : BH2-400B SP
- ✓ model : BH2-600B SP
- ✓ model : BH2-700B SP
- ✓ model : BH2-1200B SP
- ✓ model : BH4-150B
- ✓ model : BH4-300B SP
- ✓ model : BH4-400B SP
- ✓ model : BH4-600B SP
- ✓ model : BH4-700B SP
- ✓ model : BH4-1200B SP



EUROPASCAL GmbH - An der Wiesenhecke 10 - 63456 HANAU - Germany
Phone : +49 6181-42309-0 / Email : aremeca@europascal.de
Website : www.aremeca-instrumentation.com or www.europascal.com

Your Model :

Serial number :

Made the :

to contact Sales Manager : d.regal@aremeca.fr

SUMMARY

	Pages
1 - GENERAL	4
2 - SECURITY	5
a) Device	5
b) User	6
3 - PUT INTO SERVICE	7
a) Unpacking the unit	7
b) Installation.....	7
c) Put into service.....	9
d) Test run after installing.....	10
4 - PROCEDURE	11
a) General	11
b) Procedure models BH2 BH4 DP	12
c) Procedure models with calculator	15
1 - Button functionality F1 : realization of a calibration with the calculator.....	16
: Dead weight leakage time	24
2 - Button functionality F2 : visualization of the piston.....	26
3 - Button functionality F3 : adjustable parameters and ambient data.....	27
4 - Button functionality F4 : dead weight configuration	28
: sensors calibration.....	32
: calculation test mode	34
: special functions	36
5 - Calibration/Certificate/Distance sensor adjustment	37
6 - Cleaning/Maintenance	39
a) Daily maintenance	39
b) Full review.....	40
7 - Annexes	42
Options.....	42
Accessories.....	42
Consumables	43



Read the instructions before handling and retain this information for future use.

All rights reserved AREMECA

Dead weight tester models BH2 or BH4 describes in this manual are designed and manufactured by AREMECA (France).

Our products follow manufacturing procedures and controls in line with our Quality System ISO9001 version 2015 and in accordance with the standards in force.

This manual commissioning informs the user about the functioning of the instrument and the safety limits for work peacefully.

This manual is an integral part of the device. It must be kept close to the workstation and accessible at any time by the user.

AREMECA reserves the right to alter the content or form of this manual at any time and without notice. And to make technical amendments to change the product.

Responsibility AREMECA is not liable for any damage caused by :

- not in accordance with intended usage,
- non compliance with instructions for use,
- use of the instrument by unqualified untrained operator ,
- a transformation / modification of the device carried by the user.

The operator must have read and understand prior to operating mode and use the device to start handling.

a) Device

Device Identification



indicates the model of dead weight
ex : BH2-150B

indicates the serial number of dead weight

indicates the date of commissioning of the unit

Intended use of the device

Before switching on the device, ensure that the technical characteristics (measuring range, precision, fluid etc...) correspond to your needs.



> For example : the maximum pressure defined for this compressor must not be exceeded

The pressure compensator is designed and manufactured for use as described in this document.

In this case of misuse or mishandling, outside the technical specifications contained in this manual. The instrument must be immediately isolated, identified as inoperative and must be checked by our service department.

Precautions storage and transport

It's necessary to take care of the unit during storage or transportation. It must be protected from moisture, shock, extreme temperatures and shouldn't be removed or changed.



*> On our catalog, we have a suitcase, adapted to transport your device.
(Ref.OP0002)*

If the dead weight is moved to a new environment (warmer, colder, etc...). Observe the phase of "quarantine" and wait until the device temperature stabilizes at room temperature before handling.

b) User

User qualifications



> Improper use of the device can cause significant bodily injury and property damage.

Qualified operator, due to : its product training, knowledge in the field of metrology and experiences in field of pressure and knowledge on standards and guidelines, is able to perform the operations describes in this manual. He will be able to detect potential dangers.

AREMECA offers on demand, an installations / commissioning of the instrument performance.

Personal protective equipment (PPE)

The personal protective equipment must be defined in the security register of the user company and made available to the operator. These devices are used to protect the operator from potential risks that impede their safety and health at work.

a) Protecting fluid



> Wear eye protection : protects the eyes against splashes and projections of the fluid.



> wear gloves : protect the skin against irritation, allergies.

AREMECA provides for oil dead weight, a bottle of colorless mineral oil. Safety data sheet of used oils are available on request.

b) Heavy lifting



> wear safety shoes : protects against crushing during drop weight.

Ergonomics and workstation management are necessary to facilitate the work of the operator and avoid musculoskeletal disorders.

a) Unpacked the device

Upon receipt of the equipment, check the status and content of your package. All of the following elements must be present in the package :

- 1 compressor
- 1 set of weights
- 1 piston/cylinder
- 1 bottle of 0.5 liters of oil for the models BH2 or BH3 or BH4
- 1 capstan consists of 4 delivered arms removed
- 2 connectors G1/2 (supplied as standard unless otherwise specified)
- 1 manual

Check that there isn't damage or breakages during transport. If there are missing items, please immediately notify AREMECA or your local distributor for what is missing.

b) Installation

Preferably, install your unit in a stable and controlled environment.



You will get better performance if :
 > the temperature and humidity of the room are stable,
 > the workstation is clean and dry, protected from drafts, noise, vibration, and without passing

Component Identification

- 1 : capstan
- 2 : axis of rotation
- 3 : clamping knob
- 4 : connector
- 5 : valves (A and B)
- 6 : sidesteps
- 7 : filler cap
- 8 : set piston / cylinder

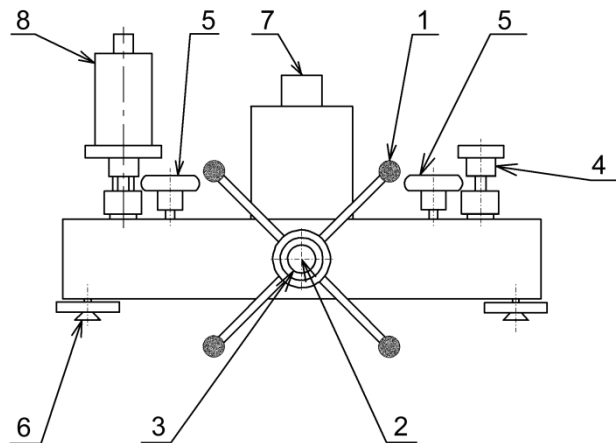

Installation / Assembly

- Install pressure generator on a established stable an rigid about 0,90 m tall.
- Adjust the stability and adjust stability of the generator through sidesteps 6.
- Insert the capstan 1 on the axis of rotation 2, the screw tightening knob 3 to the axis of rotation.
- Remove the yellow caps protections pressure connections.

- Make sure the O-rings are positioned in their throats.

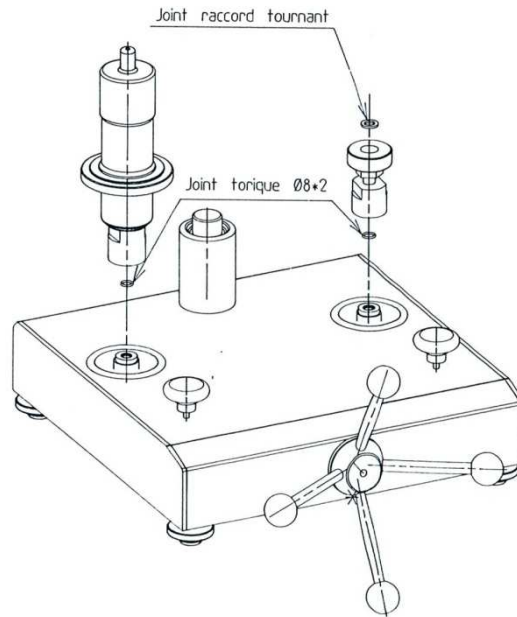

- Install the piston / cylinder 8 on the connector left. According to the following plan :

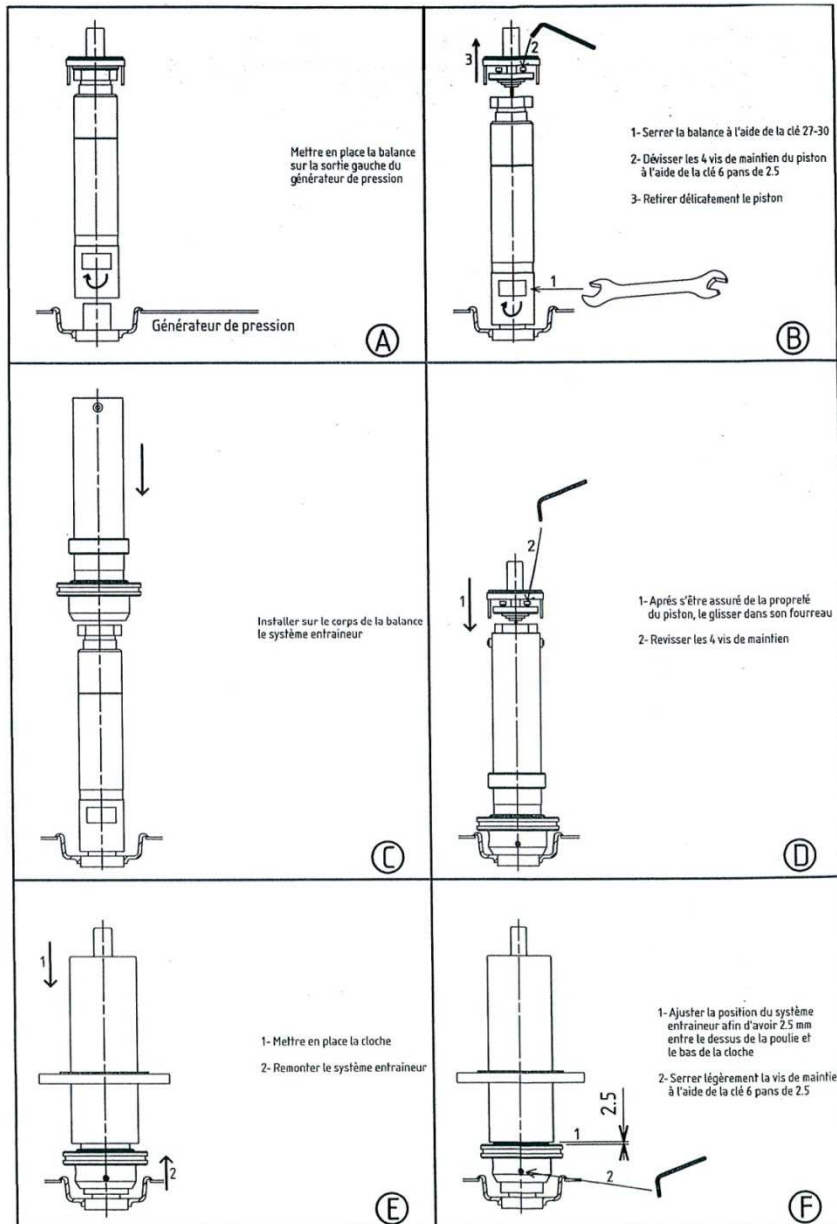

- Fit the adapter to turn **4**. Connector on the right nut. Make sure the O-rings sealing ring are well positioned.

> Dirty or polluted gauges must be cleaned before mounting the pressure generator to prevent contamination on the hydraulic circuit. Don't clean the tank with alcohol

Option : cleaning bench (Ref.OP0062)



The installation of a separator is recommended for calibration of instruments that were used on corrosive, so that traces of its products don't cause etching on the circuit of the pressure dead weight and in particular on the piston/cylinder assembly.

Options : separator (Ref.OP0023)

c) Put into service

> generators are equipped with precision valves instrumentation, it is imperative to observe the following guidelines to keep your machine in good working conditions.



Filling the unit with the fluid

1. Open the valves **5** (noted A and B) and turn the capstan **1** in the direction of clockwise until you reach the stop limit before.
2. Unscrew the filler cap **7**.
3. Fill tank 3/4 with oil. Replace cap fit **7**. Measuring device or control test on the swivel **4**.

> Our devices are mounted and designed for a "standard" use. They work with the supplied fluid. Some fluids such skydrol, castor oil etc.... are corrosive and can damage the sealing ring of your device



On request : we can deliver a device designed for these fluids.

4. The capstan **1** turn anticlockwise until it reaches the stop end position.

Purge unit

5. Turn the capstan **1** in the direction of clockwise until you reach the stop limit before to purges air from the system. Air bubbles can then appear in the tank.
6. Turn the capstan **1** anticlockwise until it reaches the stop end position.

7. If necessary replenish the tank.

The pressure dead weight is ready for use.

d) Test run after installing

a) Perform a calibration test instrument with a "test" known correct (see chapter procedure) to verify and validate the operational statuses of the dead weight.

Note : when calibrating instruments with a large volume, the amount of fluid in the compressor may be insufficient to achieve the desired pressure. In this case the instrument is to be filled as possible before being connected to the compressor to reduce the volume of working fluid.



*> As an alternative, we provide you a hand pump with a reservoir volume of 327 cm³
Option : hand pump (Ref.OP0158)*

b) Lower the pressure by turning the capstan in the opposite direction of the needle clockwise and remove the instrument "test". If necessary use the key to initiate the unscrewing of the swivel.

c) The device is now ready for use.

a) General information on calibration

A dead weight is a device that generates pressure from two main data :

- the force generated by adding the masses.
- the effective section of the dead weight.

These two values may vary depending on environmental conditions, atmospheric pressure, gravitational acceleration, temperature, humidity.

To generate pressures in precision values $\geq \pm 1.10^{-3}$, it's necessary to verify that the local environmental conditions are close to environmental conditions to which the balance was calibrated :

- Gravitational acceleration = 9,80665 m/s²
- Temperature = 20°C
- Standard atmospheric pressure = 1013,25 Hpa
- Ambient humidity = 50%

In the following cases, apply the essential correction formula pressures generated by the dead weight :

- dead weight subject to very remote local conditions using standard conditions of it
- dead weight which you want to generate pressures in values clarification less than $\pm 1.10^{-3}$

Cf.: Table density of air as a function of pressure and temperature - See also certificate of accuracy issued with the device.

NOTE : The DWT's reference pressure is indicated by the gauge present on the compressor (see diagram below).

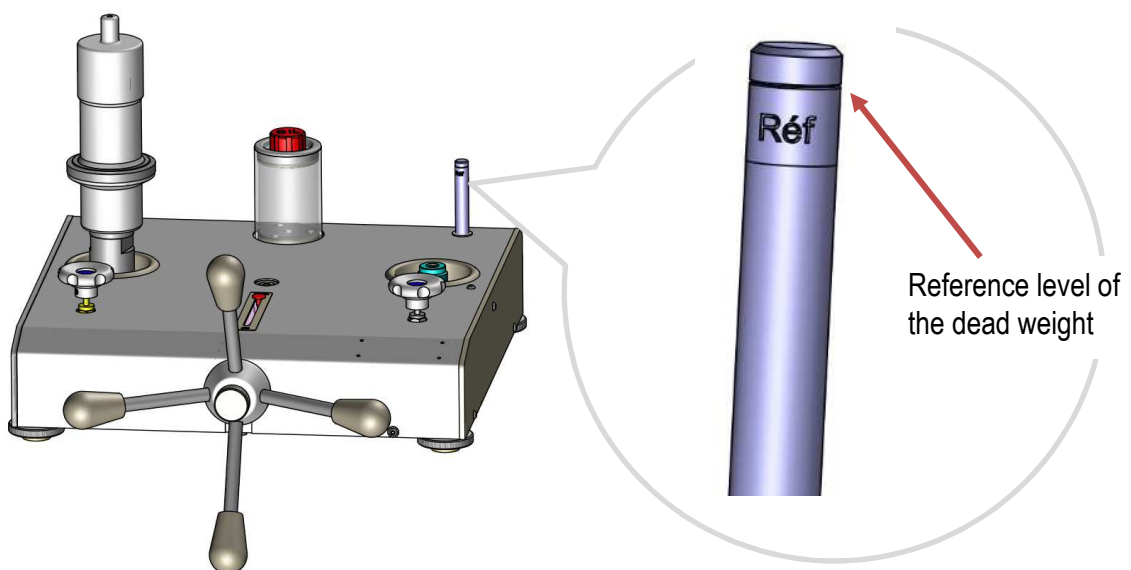

Procedure models BH2 or BH4

> Configuration of the bell and set weight of the piston/cylinder unit according dead weight measurement. Depending on the pressure value to be realized, two configurations are possible.

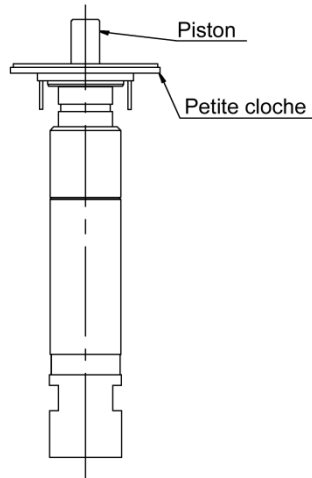

Configuration small bell

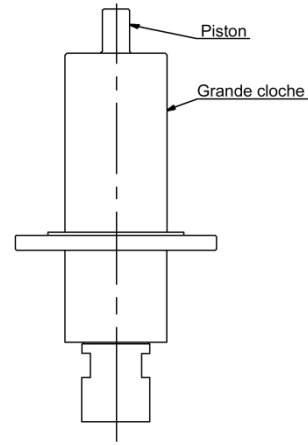

Configuration high bell

> For values of the initial pressure, depending on the scale model, see the table below.

Summary table of initial pressures								
Models	BH2-1200B SP		BH2-600B SP		BH2-300B SP		BH2-150B	
	BH4-1200B SP		BH4-600B SP		BH4-300B SP		BH4-150B	
Initial pressure small bell	2 bar	30 PSI	2 bar	30 PSI	1 bar	15 PSI	0,5 bar	10 PSI
	2 Kg/cm ²	200 Kpa	2 Kg/cm ²	200 Kpa	1 Kg/cm ²	100 Kpa	0,5 Kg/cm ²	50 Kpa
Pmax with small bell	20 bar	200 PSI	20 bar	200 PSI	10 bar	100 PSI	5 bar	50 PSI
Initial pressure high bell	20 bar	200 PSI	20 bar	200 PSI	10 bar	100 PSI	5 bar	50 PSI
	20 Kg/cm ²	2000 Kpa	20 Kg/cm ²	2000 Kpa	10 Kg/cm ²	1000 Kpa	5 Kg/cm ²	500 Kpa



> configuration "Small bell" doesn't exceed Pmax values shown in the table - if risk of damage to the piston.

> Hydraulic diagram

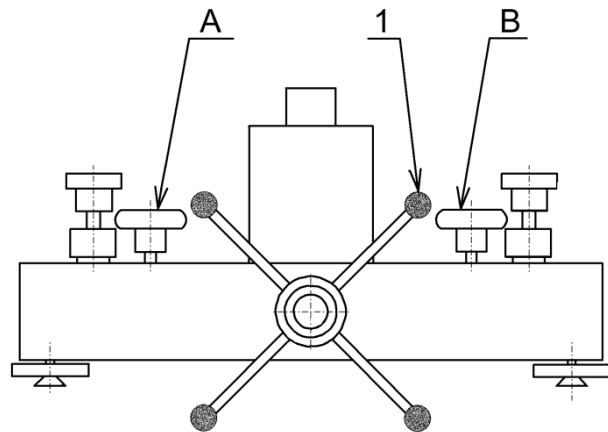
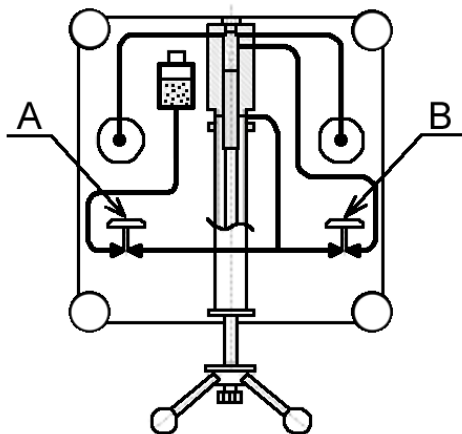

Pression / Pressure

< 120 bar / 1750 psi		
> 120 bar / 1750 psi		

1 - Pressure mounted



> *Observe the maximum operating pressures of the pressure generator*

Maximum operating pressure : BH2-150B → 150 bar and BH2-300B SP → 300 bar
and BH2-600B SP → 600 bar and BH2-1200B SP → 1200 bar

- a) Connect the instrument to be tested.
- b) Check that the valve **A** and **B** are open.
- c) Verify that the capstan of generator pressure **1** is stop end position.

1- Measurement points in the measuring range from 0 to 120 bar

d) Load all piezometric with the masses to obtain the desired pressure without forgetting the value of initial pressure of the small or high bell (see table on previous page). For better load distribution, it is preferable to install the heavier masses first.



> *precautions must be taken when handling the weights :*

- *each weight should be handled individually.*
- *when loading on dead weight, load weight gently without hitting all piezometric.*

- e) Close valve **A**, open valve **B** turn the capstan **1** in the direction of clockwise : so you can still build up pressure until the piston head fleet (area indicated by a yellow beach in HP Setup). It's thus up to max pressure 120 bar.
- f) Put the rotating weight (by hand 0,5 tr/s for BH2 - with motorization).
- g) Conduct the survey measuring point on the measuring range from 0 to 120 bar.**

To achieve the following process (in the measuring range from 0 to 120 bar)

- h) Move scale bottom stop **1** by turning the capstan in the opposite direction of clockwise.
- i) Then return to step d) of the preceding paragraph "1- point from 0 to 120 bar" .

2- Measuring points in the ranges > 120 bar

- d) Move scale bottom stop **1** by turning the capstan in the opposite direction of clockwise.

e) Load all piezometric with the weights to obtain the desired pressure without forgetting the value of initial pressure of the high bell (see table on previous page). For better load distribution, it's preferable to install the heavier weight first.



> precautions must be taken when handling the weights :

- each weight should be handled individually.*
- when loading on dead weight, load weight gently without hitting all piezometric.*

f) Close valve **B** and open valve **A**, turn the capstan **1** in the direction of clockwise : so you can still build up pressure until the piston head fleet (area indicated by a yellow beach).

g) Put the rotating weight (by hand 0,5 tr/s for BH2 - with motorization).

h) Do the measuring point on the measuring range from 120 bar to 300 bar or 600 bar to 1200 bar depending on measuring range of the dead weight.

To achieve the following points of measurement (in ranges > 120 bar)

i) Bring the dead weight down stop by turning the capstan **1** anticlockwise.

j) Then return to step d) of the preceding paragraph "2-point measurement > 120 bar" .

3 - To lower the pressure and release the end of the measuring cycle

a) Completely turn the capstan **1** anticlockwise until the gauge indicates a pressure close to the 0 and slowly open the valve **B**.

b) We can then open the valves without risking an abrupt descent of masses damages all piezometric.

These dead weight testers high performance incorporate a calculator : with dynamic visualization of the position of the piston, with automatic display of the pressure generated by the dead weight depending on the sensors : temperature, atmospheric pressure, with a connection for transferring data on a computer allowing full traceability.

This product is essential for the calibration of high-accuracy

Functionality of the calculator :

As soon as the calculator is powered, the user has the choice between different functions :

- **F1: Measurement** : The measurement function is used to launch the calibration process and define the acceptable criteria, to perform pressure measurements by assisting the operator.
- **F2 : Adjusting/visualization** : The display function is used to display a bargraph representing the position of the piston.
- **F3 : Settings test** : The settings and the tests make it possible to modify certain parameters such as gravitation. And to display in real time the values obtained by the sensors.
- **F4 : Configuration dead weight**: This function is used to configure various parameters of the DWT such as: entering the values of the set of weights after calibration, calibrating the sensors, modifying the time, the date and the language of the calculator. The manufacturer adjustment function is reserved for AREMECA.

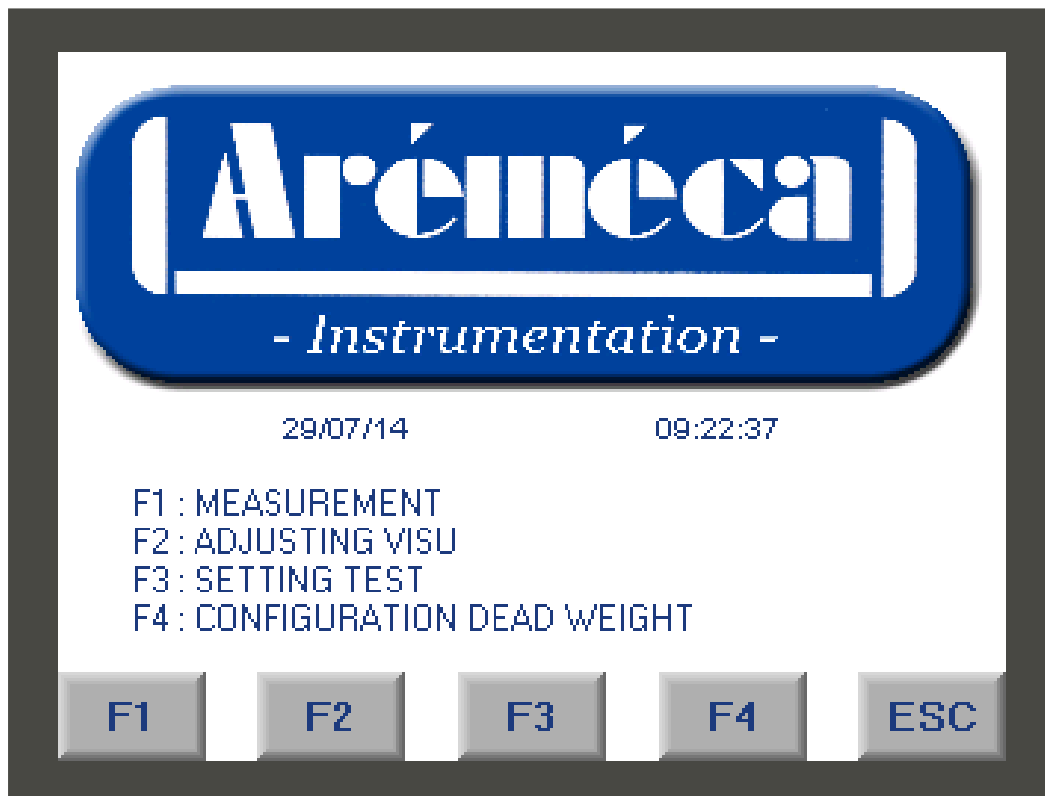

To configure the calculator with the language of your choice : see function F4 chapter [e) Special functions]

1- Functionality button F1

The function F1 is used to define the calibration criteria and to launch the measurement process with operator assistance, then to produce a certificate of calibration and to carry out a leak time.

Upstream, the operator must ensure that the calculator parameters are properly informed (see Functionality of the button F3). These parameters are entered during the manufacture of the DWT, but can be modified if necessary.

I. Realization of Measuring

On the home screen, press the button -> "F1" on the screen.

1st operation : Configuration of the test on the device to be controlled

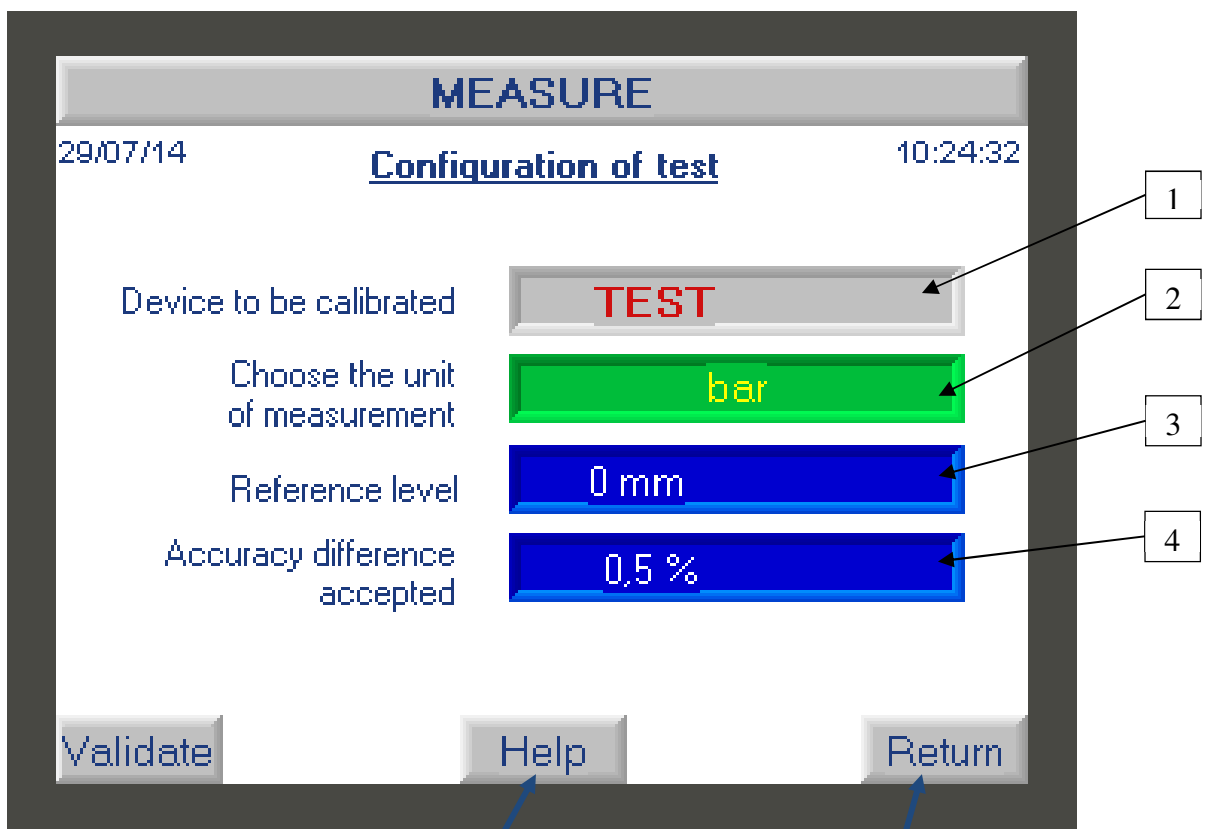

The "help" button is used to display additional information concerning the active screen.

The "Return" button allows you to return to the previous screen.

On this screen, the operator must :

- a) Enter the name or reference of the device to be calibrated (1): to do this, click on the field "Test" field -> a new window opens giving you access to an input keyboard
- b) Choose the unit of measurement (2) -> click on this field as many times as necessary to scroll through the units of measurement.

Note: the advantage of the calculator is that you can decide to work in a different unit of your weight set. The calculator will do the conversion. Example: your weight set is in bar, but the measurements/results will be in PSI.

- c) Enter the distance at which the device to be calibrated is located in relation to the reference level (3) -> click on the field to enter the level value of the device if necessary.
Note: the reference level is indicated on the scale by the indicator positioned on the housing.

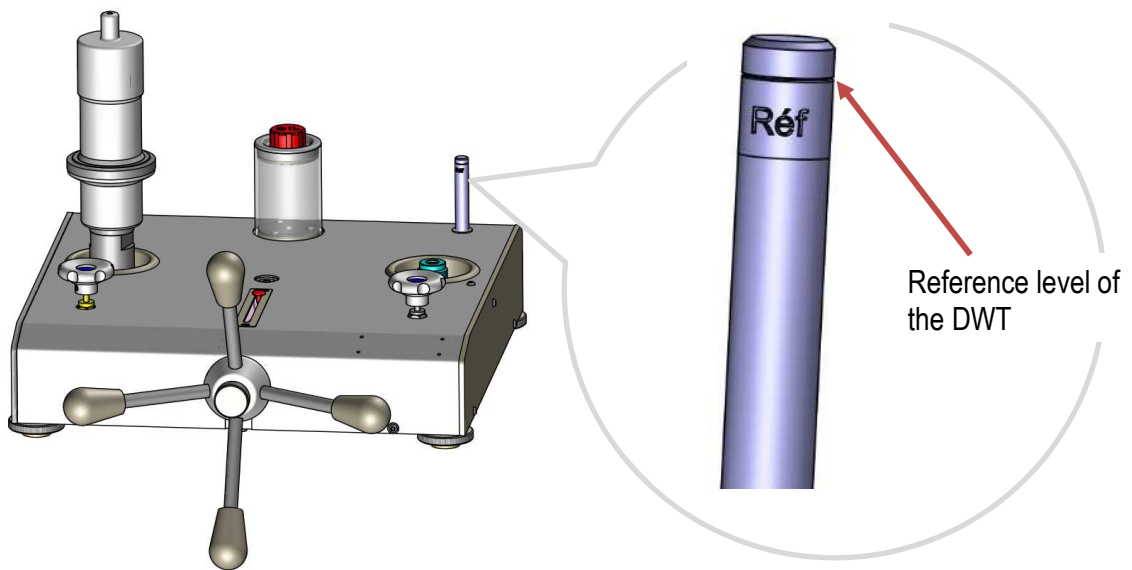

- d) Indicate the measurement deviation that you tolerate (4) -> click on the field and enter the desired value. (ex.: 1%)

Once all the fields have been filled in, press the "validate" button to go to the next screen.

2nd operation : Choice the set of weight

On the top banner of this screen you will find the following information :

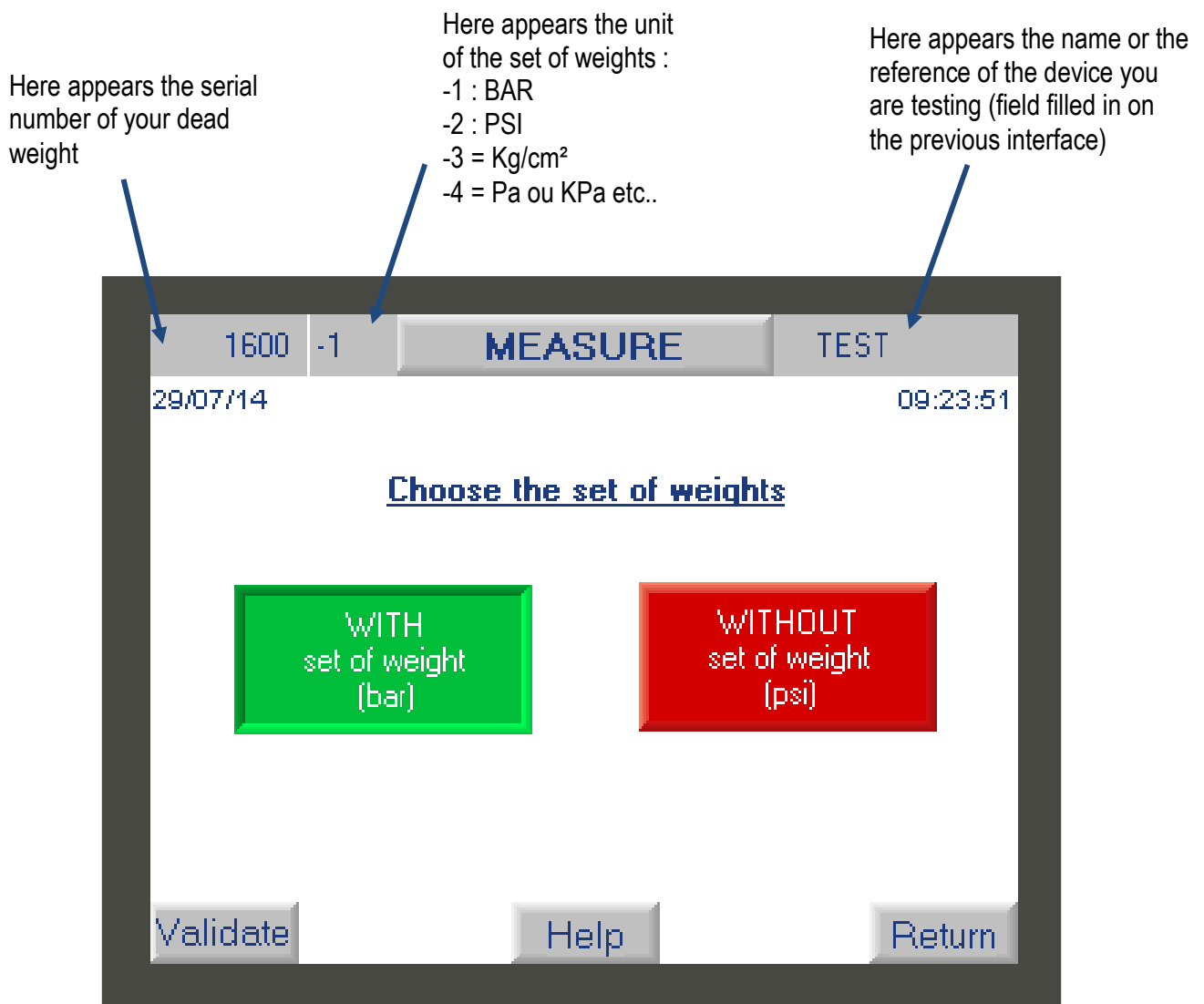

Please indicate the unit of your set of weight BAR or PSI : click on the appropriate unit to validate it. It should appear green.

When manufactured, the set of weight of the DWT can be in BAR or PSI, and some DWT have two sets of weights. The operator therefore has the possibility here to select the set of weights he wishes to use.

IMPORTANT: Each DWT has its own set of weightes, and it is impossible to interchange a set of weights with another DWT. When manufacturing a DWT, we adjust the set of weights according to the criteria requested such as gravity, the desired unit of measurement. But also depending on the piston. In other words, 1 set of weights works hand in hand with a piston, they form an inseparable pair.

Press the "**validate**" button to go to the next screen.

3rd step: entering the desired pressure value

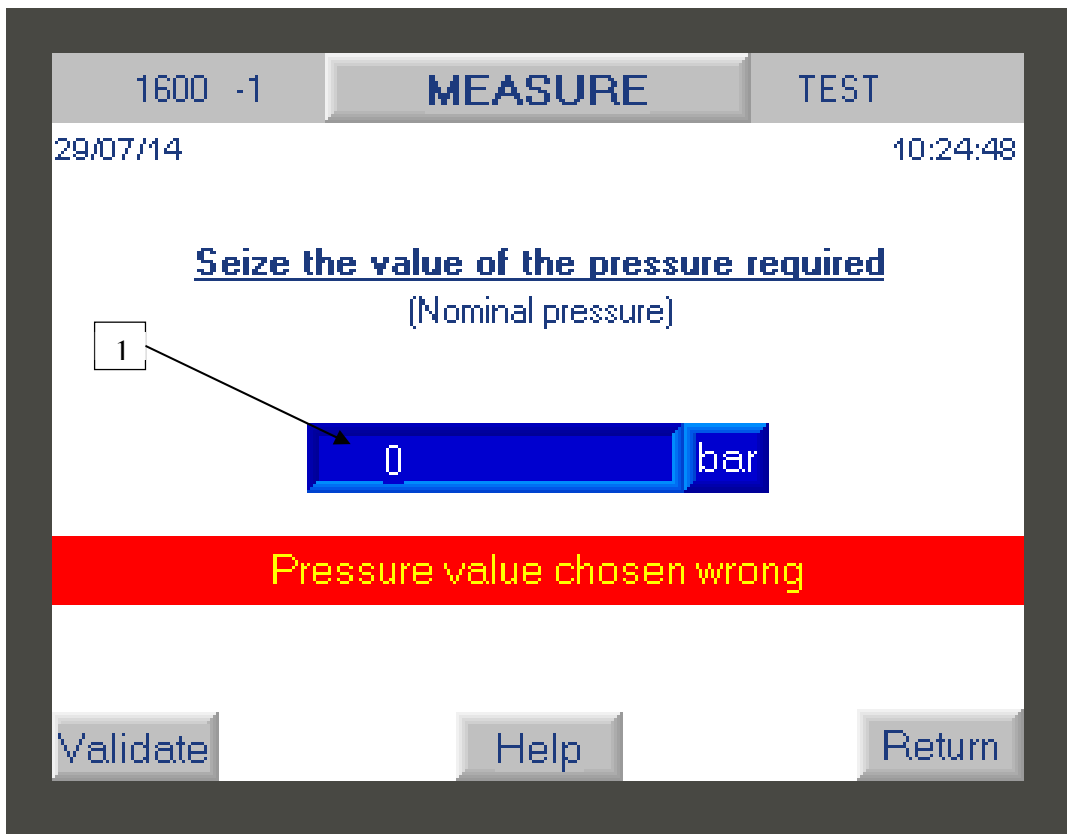

The user must enter the pressure value of his first measurement point. Please note that this value must be within the measuring range of the DWT

Click on the blue field (1) to access the numeric keypad and enter the value, then confirm it with the white arrow key.

If you inadvertently enter a value above or below the measuring (EM), then the controller will display the message "incorrect pressure value chosen". The value entered will only be accepted when the requested pressure value enters the measuring.

After entering the pressure value, press the "validate" button to go to the next screen.

4th operation: Configuration of the stacking of the weights

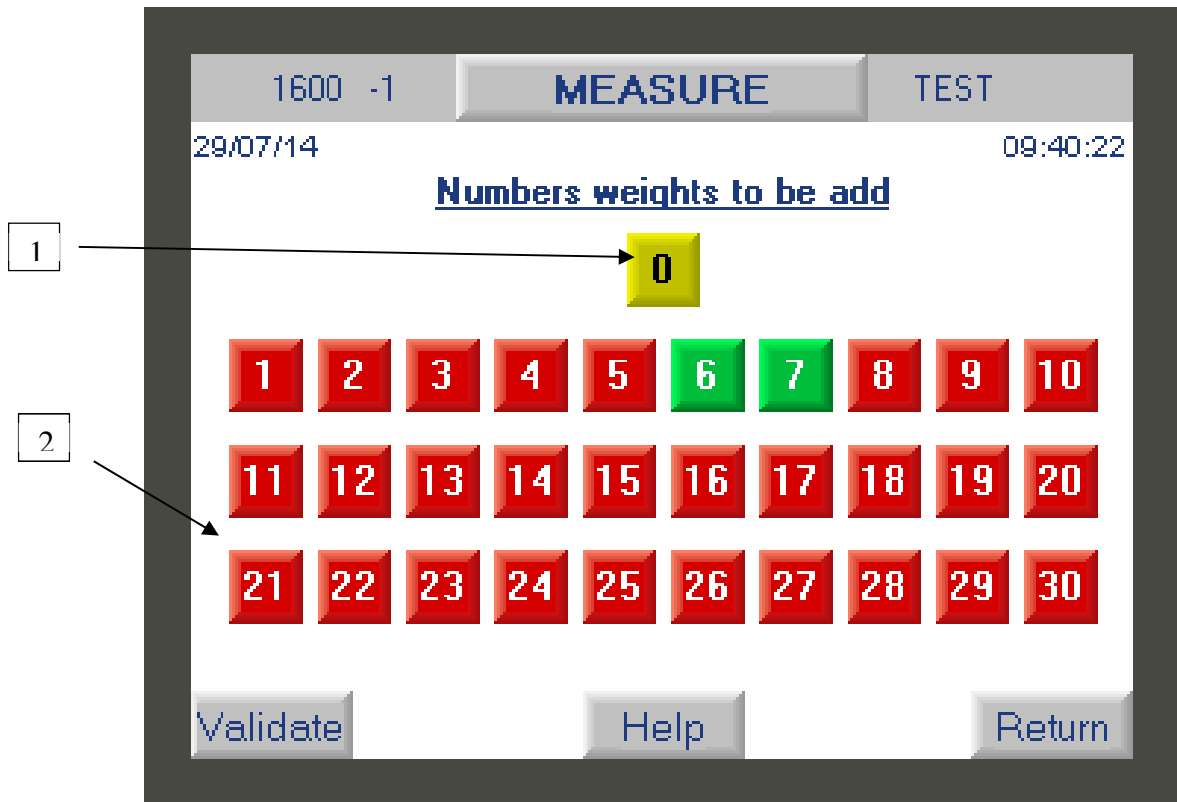

This screen displays all the weights to be placed on the bell of the DWT in order to obtain the desired pressure value (entered previously).

Weight **0** in yellow color (1) corresponds to the moving assembly, its weight rest and its adjustment crown which must always be present to perform the measurements.

The weight numbers displayed in GREEN (2) correspond to the weights that you must position on the bell to obtain the desired pressure. Weight numbers displayed in RED are weights that should not be used.

NOTE : Each weight is identified with a serial number :

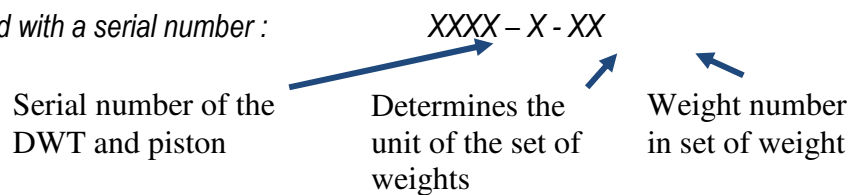

ex : weight number 1 = XXXX - X - 01

IMPORTANT: *Weights must be handled with care. It is important not to hit the bell with the weights during installation so as not to break the piston.*

Check that all the weights requested are in place on the weight rest and that they are rotating.

Press the "**validate**" button to go to the next screen.

5 operation : test result

This screen displays the pressure value obtained with the weights added in the previous step.

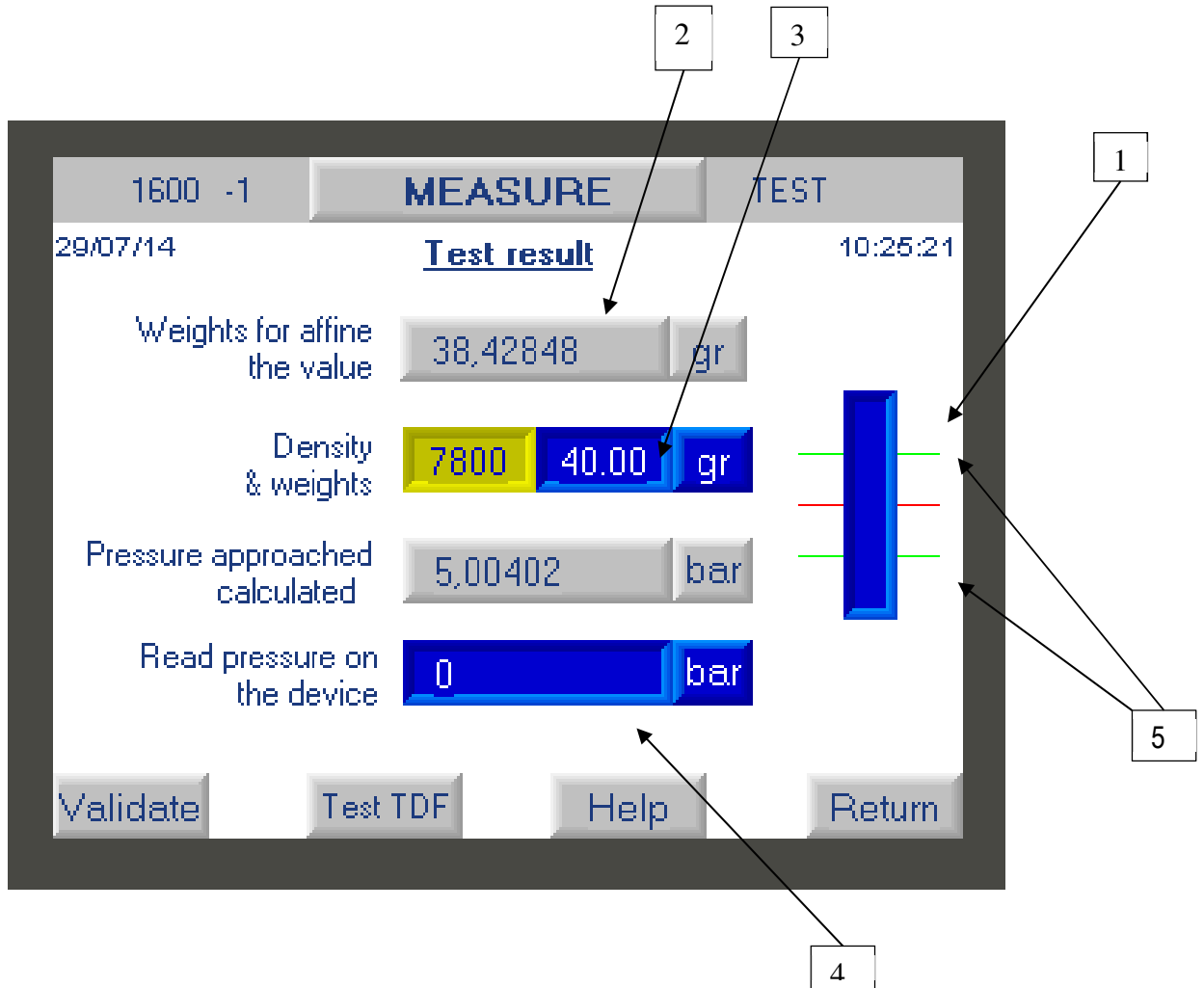

a) Before validating the elements present on this display, the operator must ensure that the DWT is well balanced. To do this, click on the bargraph diagram (1) to enlarge it. Check that the piston is in the measurement range between the two green marks (5)

b) The calculator displays the actual value obtained. If you want to approach the exact value requested, you can add fine increment weight on the DWT corresponding to the mass value indicated (2). Note : We offer an optional set of intermediate weights and/or fine increment masses from 1mg to 50g.

If you add weights, you must enter the mass value that you added in field (3), remembering to specify the value of the density of the small weight

- For weight less than 1g \Rightarrow 2800
- For weight above than 1g \Rightarrow 7800

At this time, the new value generated pressure is recalculated.

c) You must then enter the pressure value read on the device to be calibrated in field (4). Click on it to access the numeric keypad.

d) Press the "**validate**" button to go to the next screen.

6th operation : Result/Data recording

Once the previous step has been validate, the calculator will check that the difference between the calculated pressure and the reading pressure on the device is well within the tolerance entered in operation 1

If the result obtained is out of tolerance, the calculator will display an error message

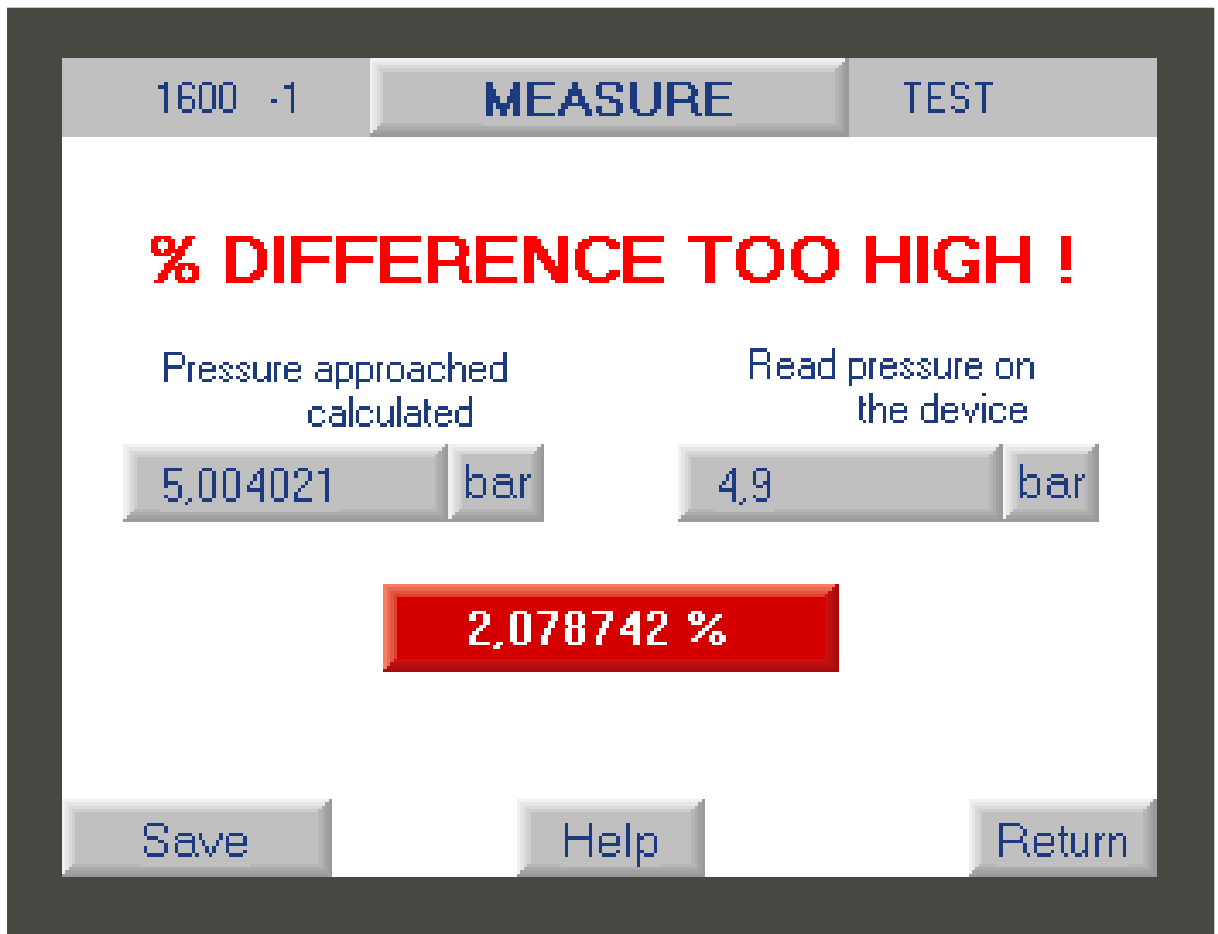

The screenshot shows a calculator interface with a dark grey border. At the top, there are three buttons: '1600 -1', 'MEASURE', and 'TEST'. The main display area is white and contains the following text and buttons:

- A large red error message: **% DIFFERENCE TOO HIGH !**
- Two columns of data:
 - Left column: 'Pressure approached calculated' above a button showing '5,004021 bar'.
 - Right column: 'Read pressure on the device' above a button showing '4,9 bar'.
- A central red button displaying the percentage difference: **2,078742 %**
- At the bottom, three buttons: 'Save', 'Help', and 'Return'.

The operator will thus be able to check that he has not made an operating error (wrong mass, error in entering the value obtained, etc.)

- ➔ If an error has been made, then he can click on "**return**" to correct it.
- ➔ If there is no error, he clicks on "**validate**"

This step ensures that the error is related to a deviation from the device under test and not to improper handling.

b) If the result entered by the user corresponds to the tolerance then a new screen will be displayed

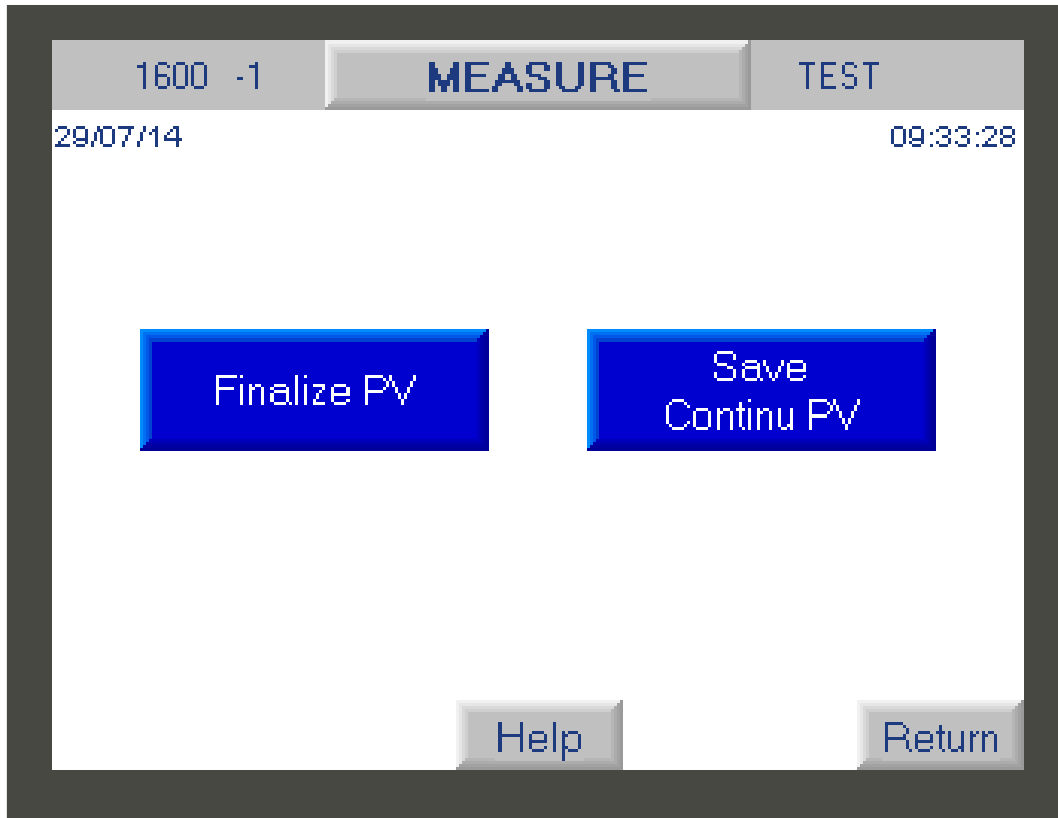

The operator will have the choice either to click on :

- **"Save-Continue PV"** : to save the result of the first measurement made and return to the first screen in order to enter the second desired pressure value (2nd measurement point) and so on to perform all the points of the measure.
- **"Finalize PV"** : saves the measurements made and returns to the main screen of the F1 button.

II. Do the leakage time of the dead weight.

You can perform a leak time during a measurement ("F1" key) to check that your scale has no leaks and is working correctly.

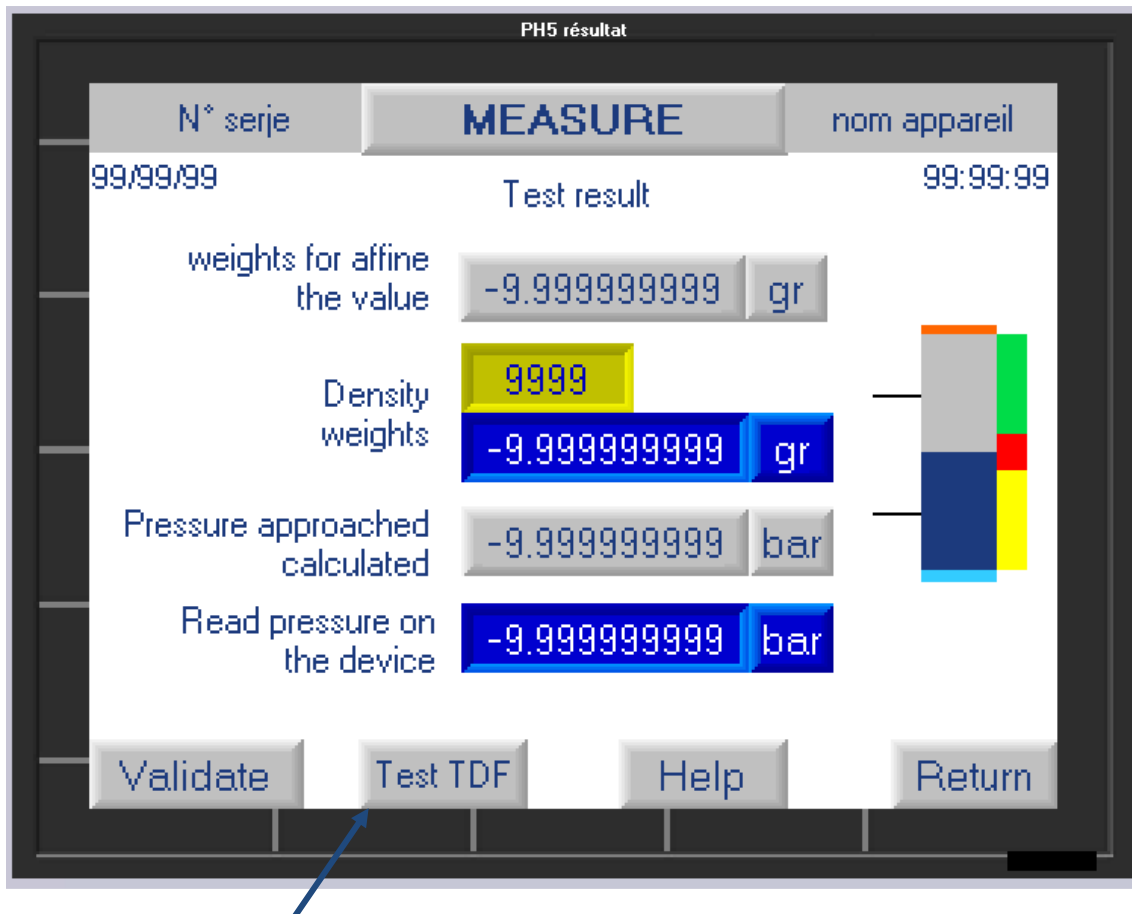

The user can click on "Test TDF" then the calculator will display the following screens.

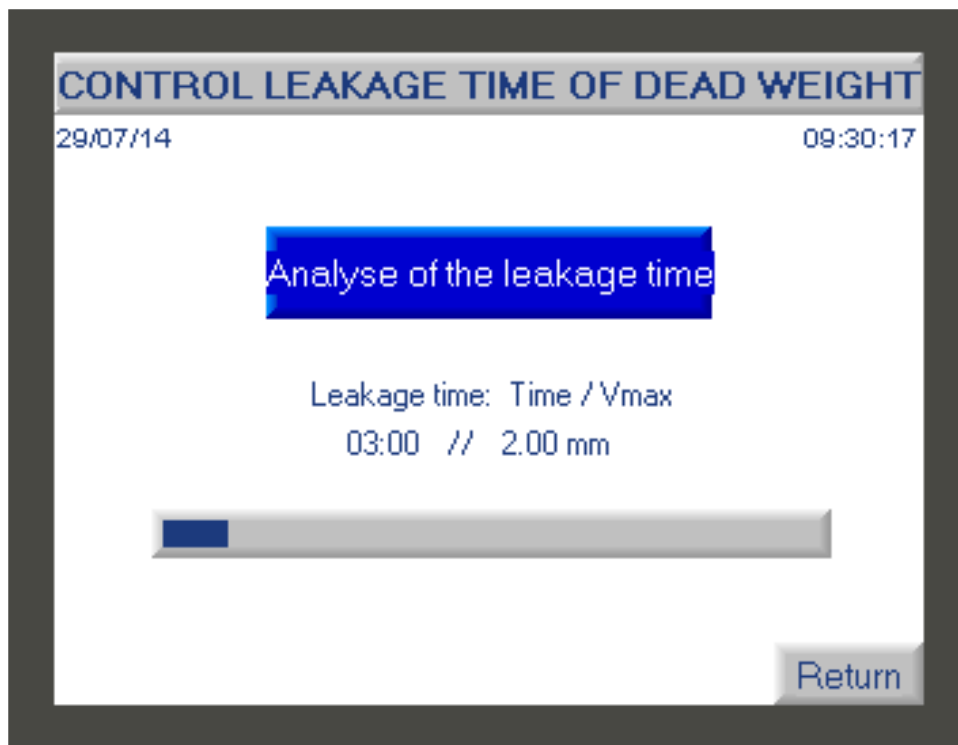

This screen analyzes the leakage time of the dead weight by comparing its descent speed with the information seized in the manufacturer settings. (see paragraph 3 - button Functionality F3).

Leakage time result :

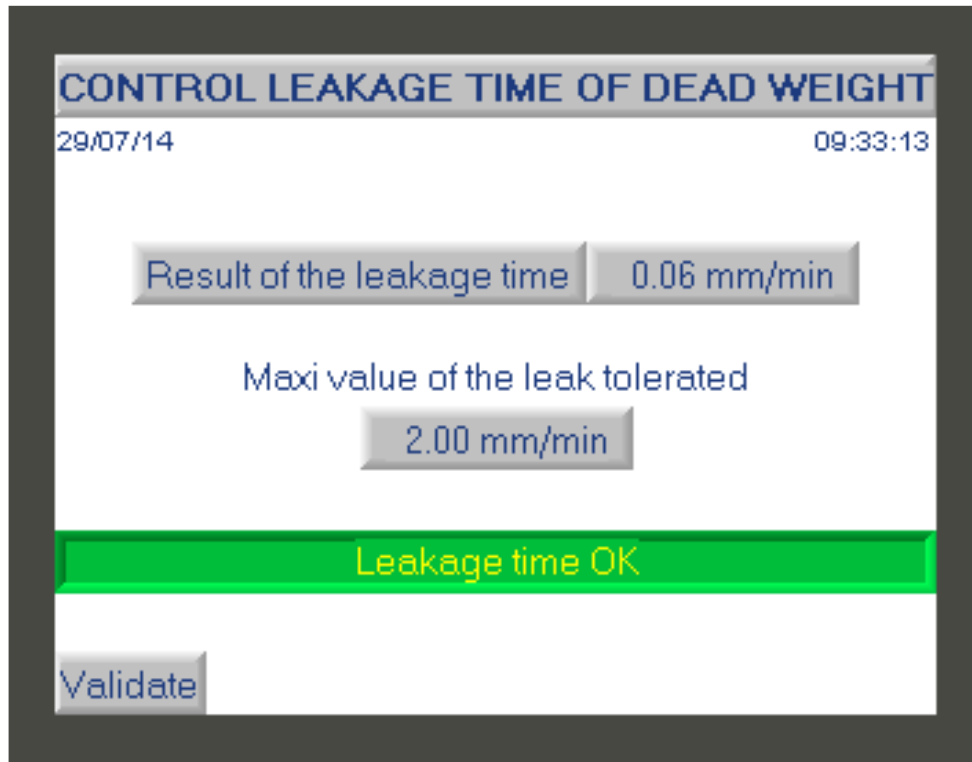

The acceptable leakage time value depends on the DWT model and is defined by AREMECA.

If the leak time is not good then the user will have to check that there is no apparent leak linked to a bad connection, a damaged seal, oil leak, bad purge etc...

If the leak persists, then contact our after-sales service (contact details given on the cover of this manual) or contact us via our website: www.aremeca-instrumentation.com

2 - Button functionality F2

The visualization function allows you to display a bargraph representing the position of the piston and to check that the DWT is well balanced.

To access this function press the "F2" key on the home screen.

A new screen is displayed with a bargraph representing the position of the piston in the DWT.

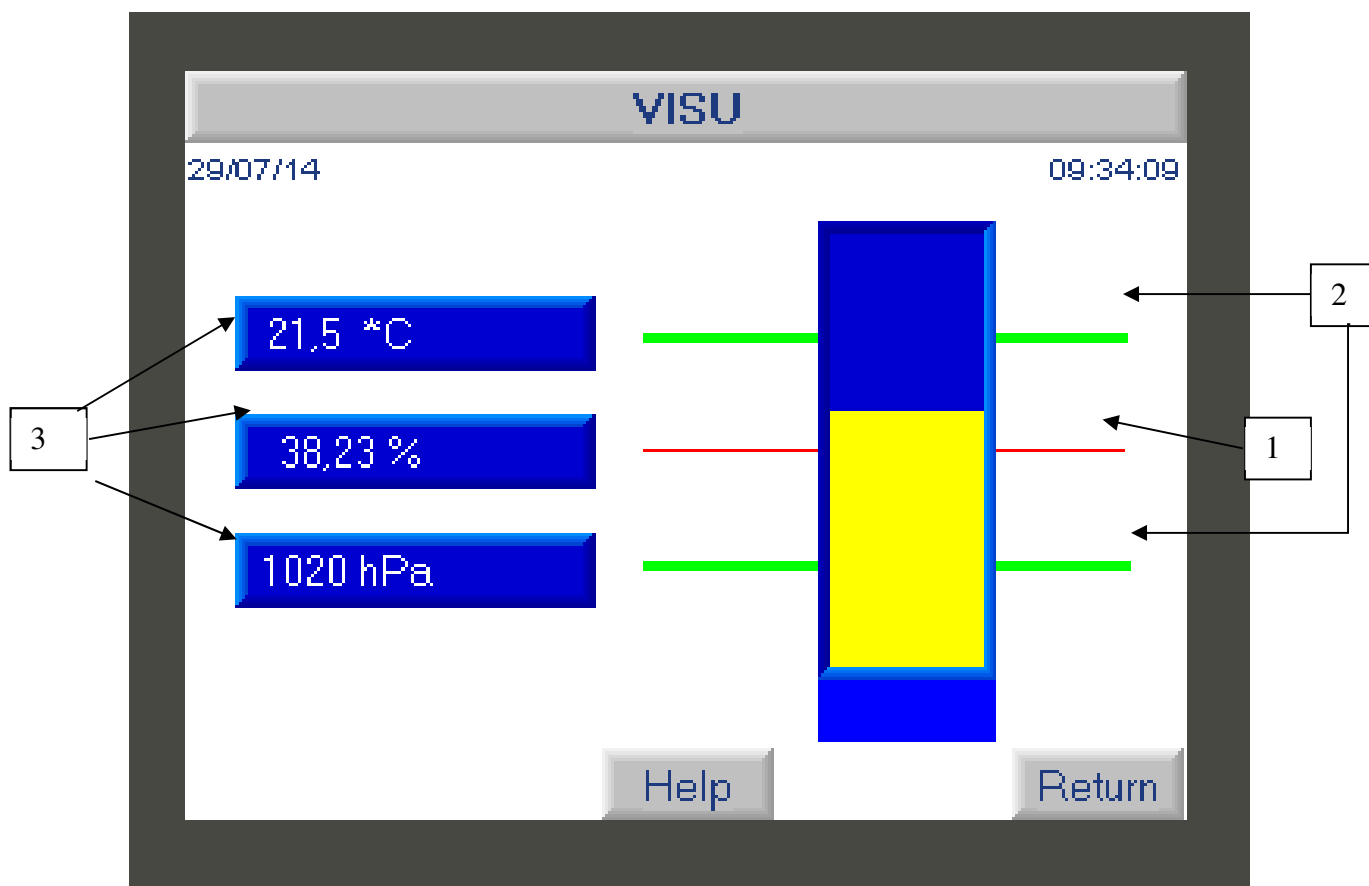

If the user presses the button "F2" on the screen then he will see a bargraph representing the If the gauge (yellow color) stabilizes on the red mark (1) then the DWT is in perfect balance. The value is acceptable if the gauge is between the 2 green marks.

If the gauge is beyond the two green marks (2) then the value of the pressure generated is distorted.

This screen also displays the values obtained by the sensors: temperature, atmospheric pressure (3). These values can be frozen if necessary.

Press the "Return" button to move to the home screen.

3 - Button functionality F3

This Test settings function allows access to the test settings and to modify certain parameters such as gravity. It also allows real-time display of the values obtained by the sensors.

I. Variable parameters to be entered

On the home screen, press the "F3" button on the home screen, to modify the following parameters :

- the local gravitational acceleration (1).
- the altitude of the device to be calibrated (2).
- the time of the leakage time (3) and the distance that the dead weight should go up this time. The leakage time is defined by the manufacturer. See OIML standard

To modify one of the variable parameters, click on the blue field you wish to modify to access the input keyboard.

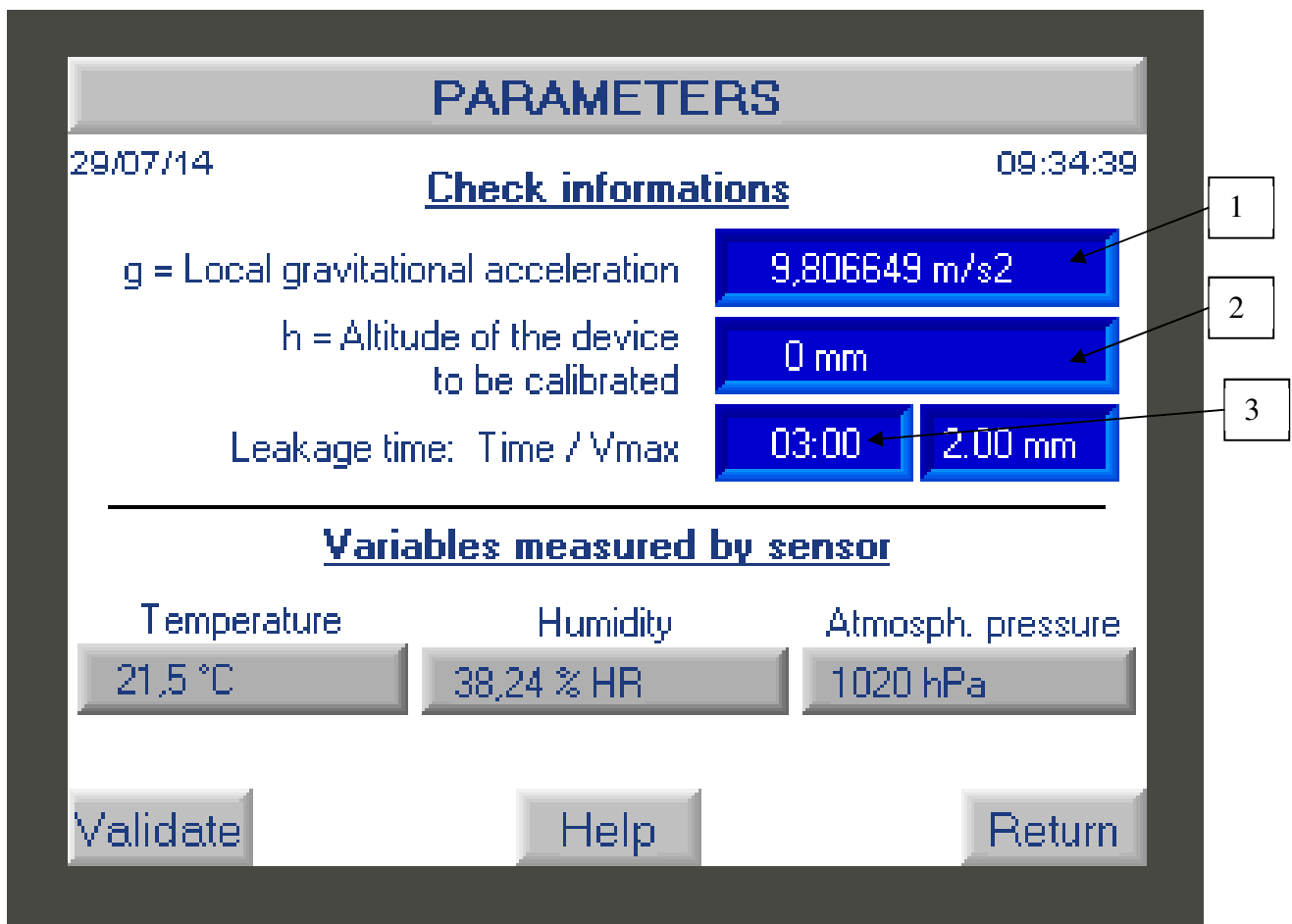

II. Variables measured by sensor (ambient data).

The screen displays the variables measured by the various temperature, humidity and atmospheric pressure sensors. These values can't be changed.

Note: You have the option of checking the conformity of the sensors with function F4

Press the "**Validate**" button to save the new data or "**return**" to return to the home screen.

4 - Button functionality F4

This function is used to configure various parameters of the DWT such as: entering the values of the set of weights after calibration, calibrating the sensors, carrying out a calculation test, modifying the time, the date and the language of the calculator. The manufacturer adjustment function is reserved for AREMECA.

IMPORTANT: Access to these functions requires entering a password

On the home screen, press **F4** to access the different functions :

Dead weight setup

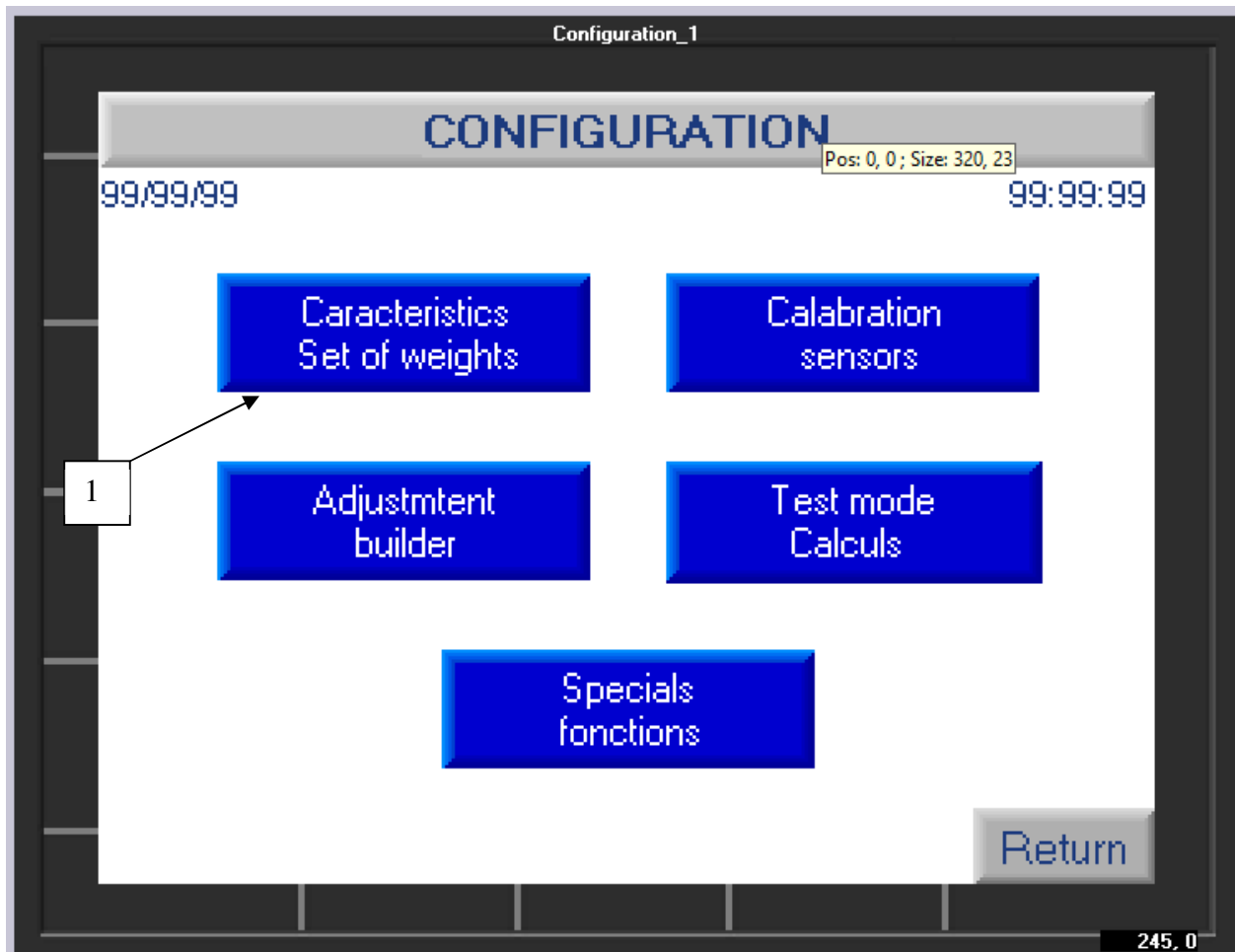

a) Characteristics of the set of weight and of the piston following a new calibration

During the manufacture of your DWT, we manufacturer, entered the weighing values of your weights, the characteristics of the piston etc.... If you calibrate again your DWT, you will have to check/correct these values with those indicated on your new COFRAC or DKD calibration certificate, etc.

To access the data entry, click on the button "**Characteristic set of masses**" (1) + enter access code **1993**

A new screen is displayed with 2 options :

- piston data
- Data concerning the set of weights

a) Piston data

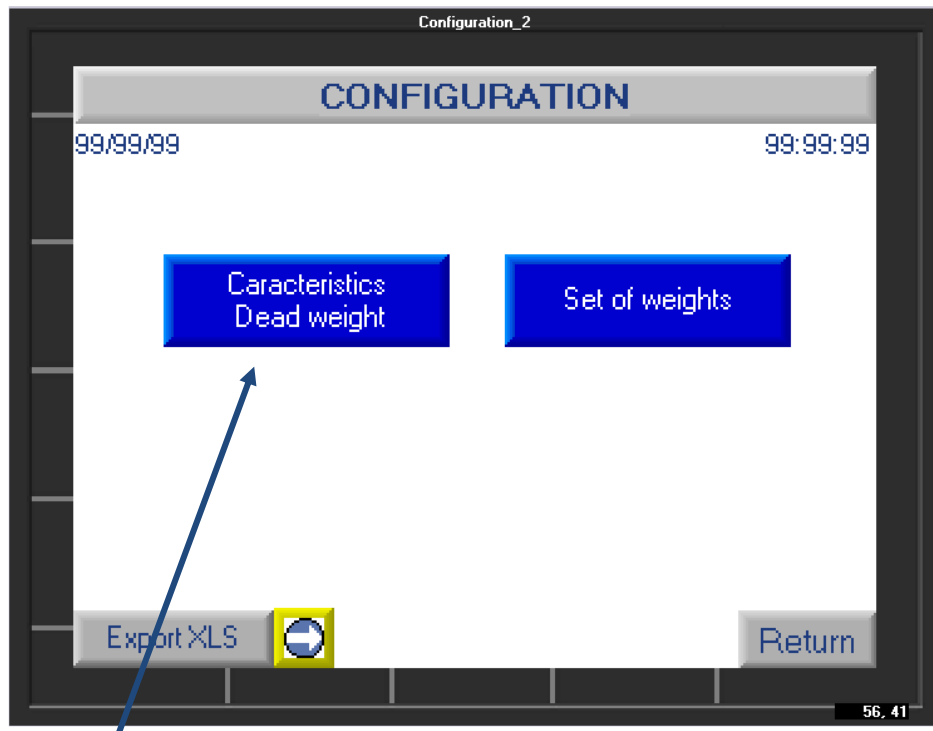

if you click on this button, you will see the following screen :

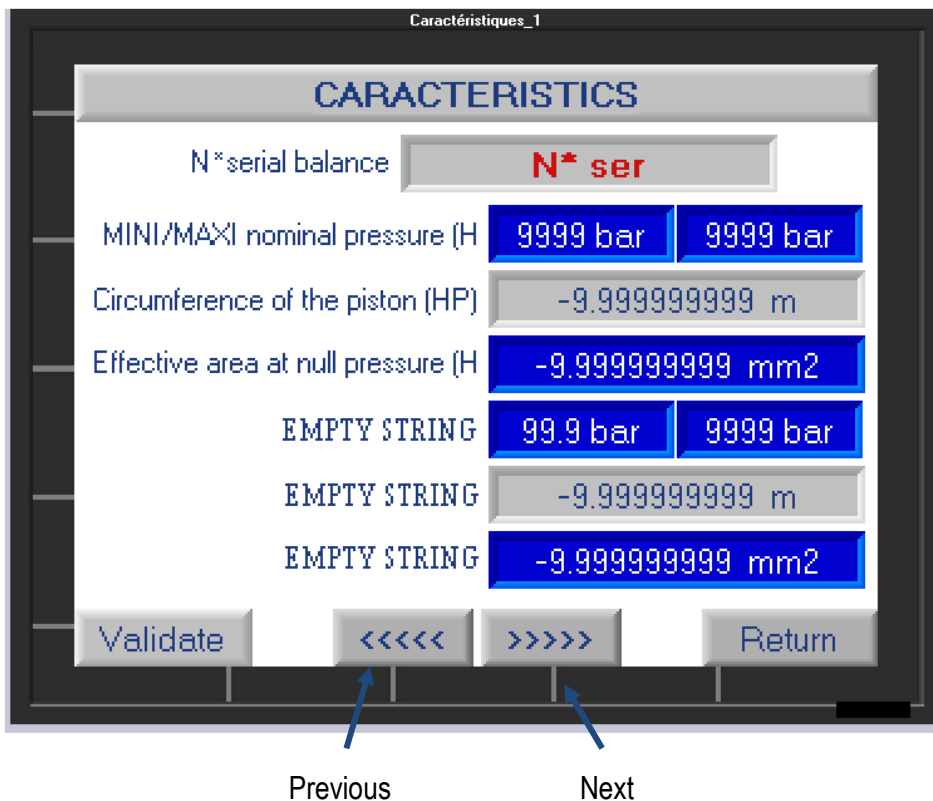

On this screen you will find the following information :

- The serial number of your DWT
- The measuring range of your DWT
- The circumference and section of the piston
- The nominal range of the piston

Note : For double piston DWT (ex: BH2-1200B DP) you will have access to the values of the BP and HP piston

Values in blue can be edited, values in gray are not editable. To modify a data, click on the blue area to access a numeric keypad, enter the value and validate.

Click on the "next" button to access other modifiable values such as the coefficient of linear expansion of the piston + sleeve etc.

If you have modified parameters remember to "Validate" otherwise press "Return"

a) Data concerning the set of weights :

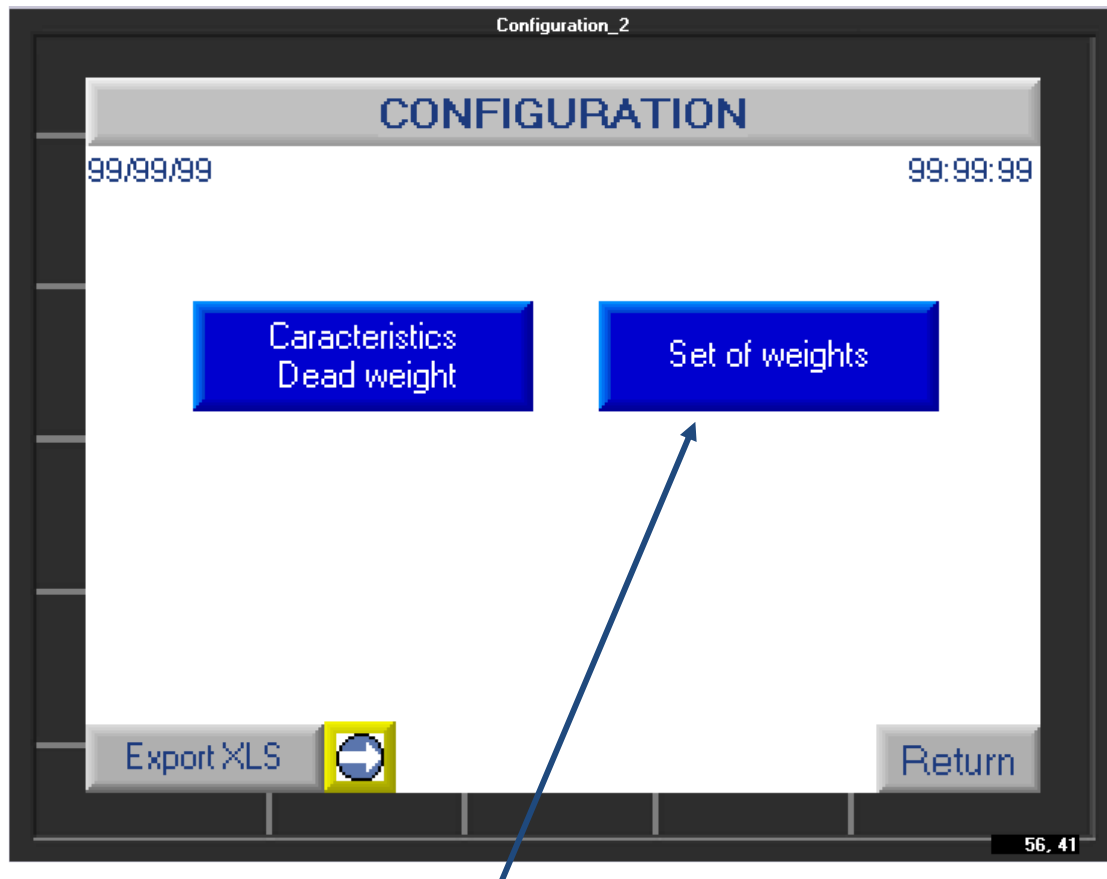

if you click on this button, you will see the following screen:

This screen allows you to view the masses and their value in grams.

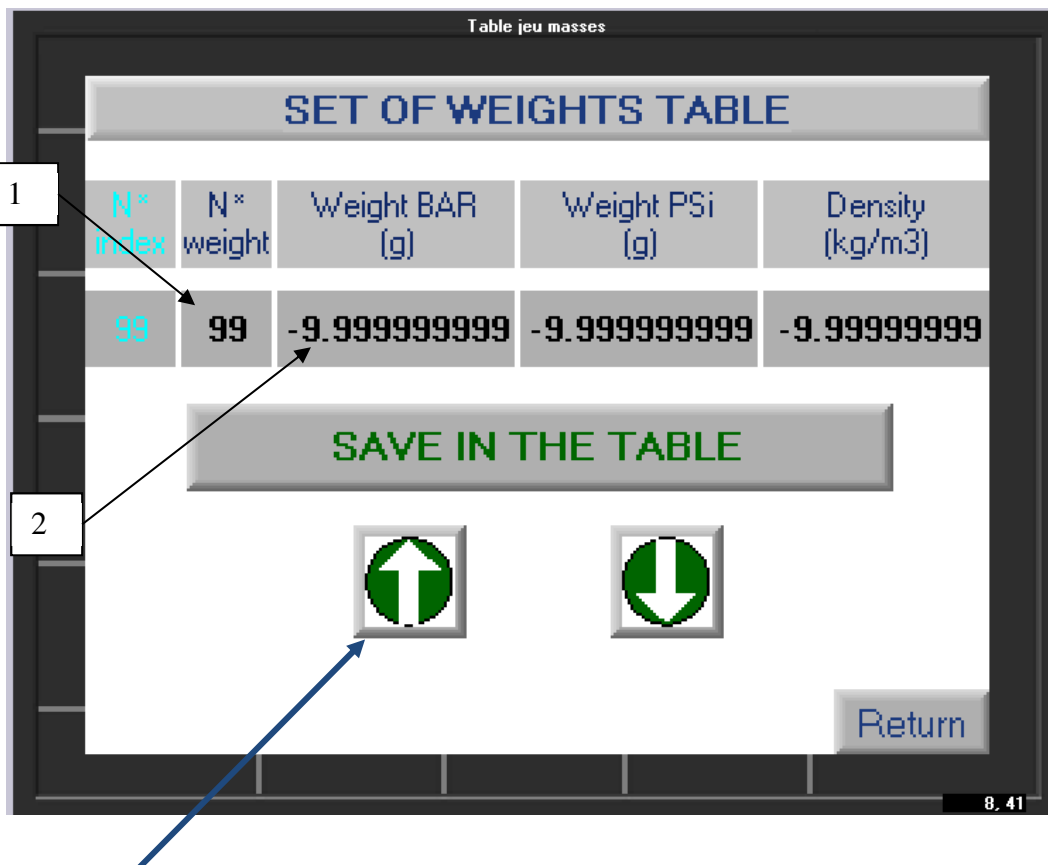

The green arrows allow you to scroll through the weights and their characteristics.

If you wish to enter the new weight value of a mass following a new calibration:

- simply search for it by its serial number (1) by scrolling through the set of weights using the arrows. You will be able to control its characteristics.
- If you need to modify a piece of data: click on the field of the value to modify (2). A keypad screen will open for you to enter the new value.
- Click on "**Save to table**" to save the entry.

Click "**Return**" once you have updated the entire weight set.

b) Calibration of the sensors (2)

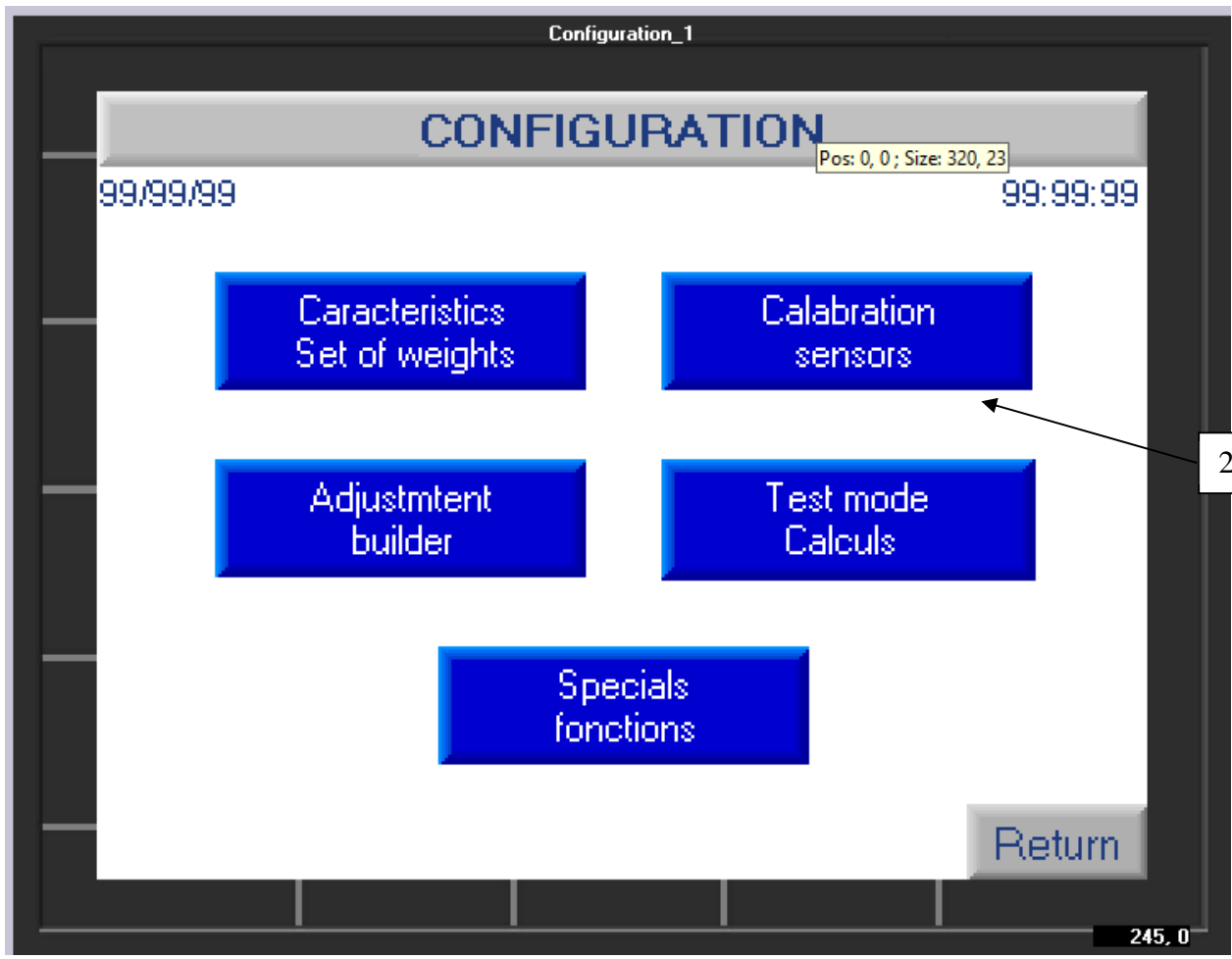

To access the sensor calibration function, click on the button (2) + the access code **1993**.
The following screen appears :

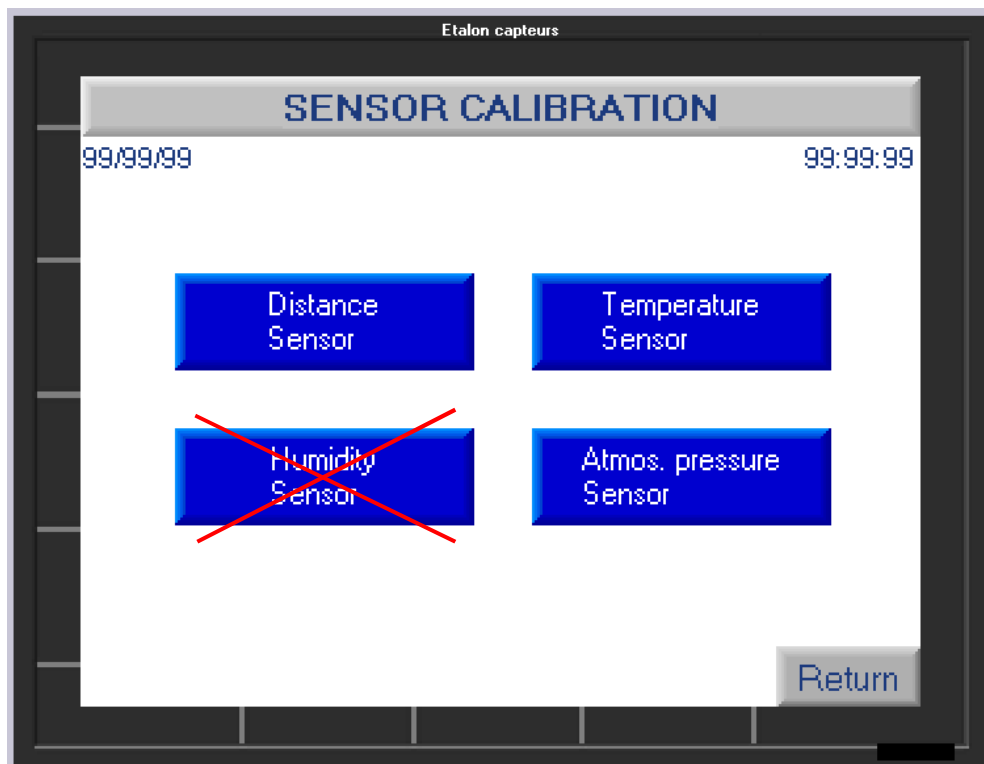

By clicking on the appropriate button, you can access the characteristics of the sensor and enter the necessary correction values. Each field in blue is editable and allows you to enter a correction value. By clicking on it, a numeric keypad will appear for input.

Note: the data entered is not saved permanently. Each time the calculator is started, you must modify these values.

Remember to "**validate**" and press "**return**" to exit.

c) Manufacturer settings (3)

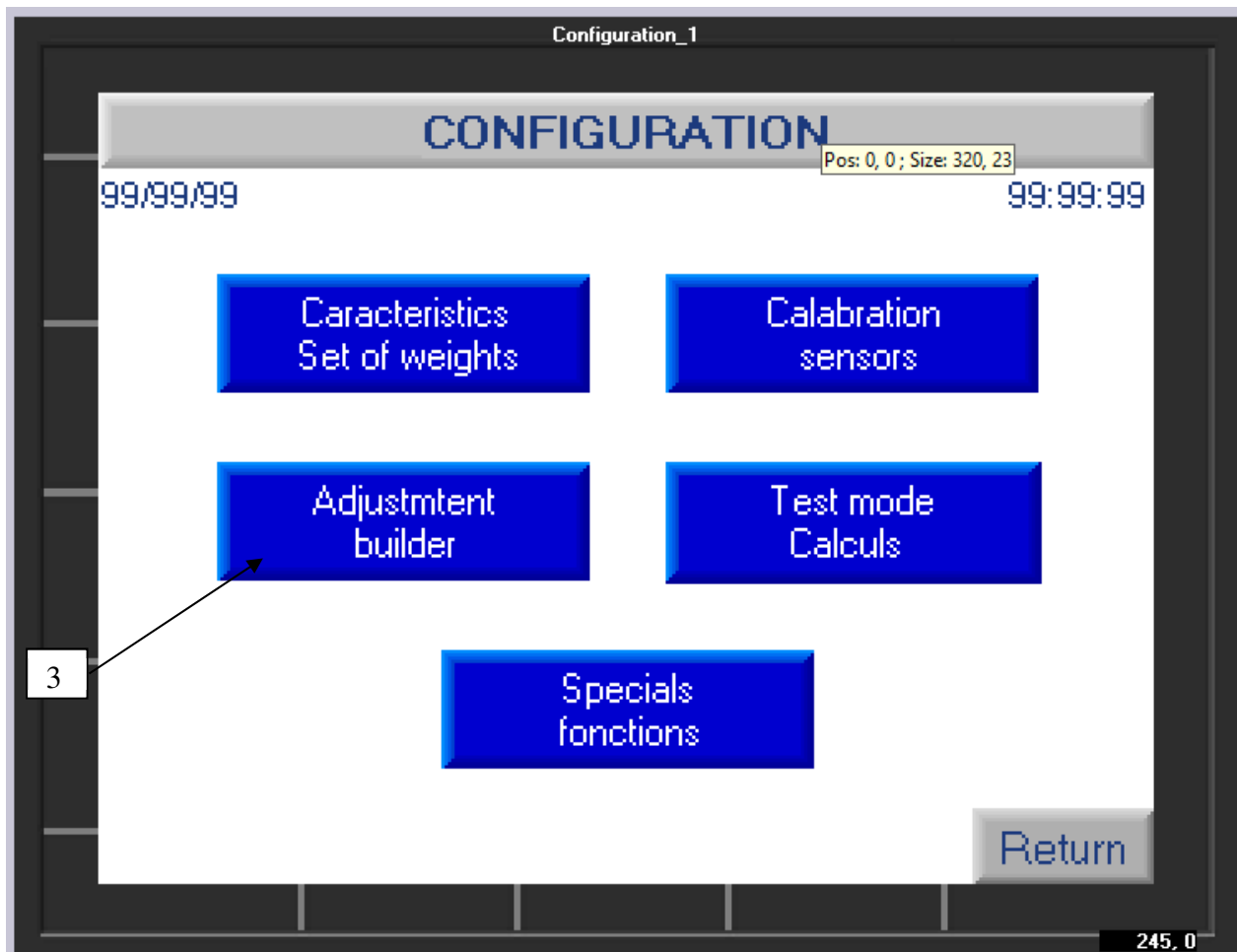

This adjustment function is reserved for AREMECA

d) Mode test calculs (4)

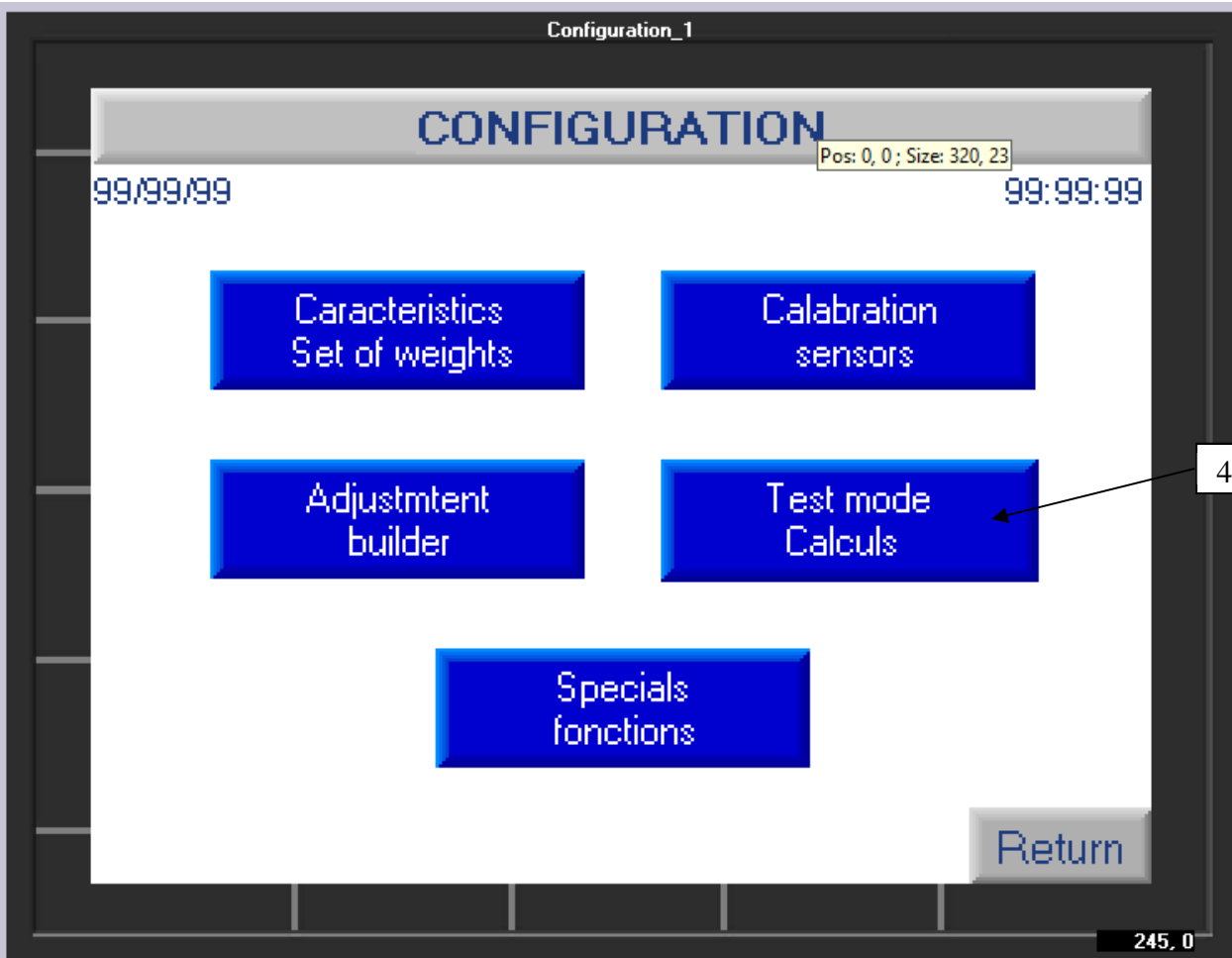

To access the test function, click on the button (4), the following screen appears :

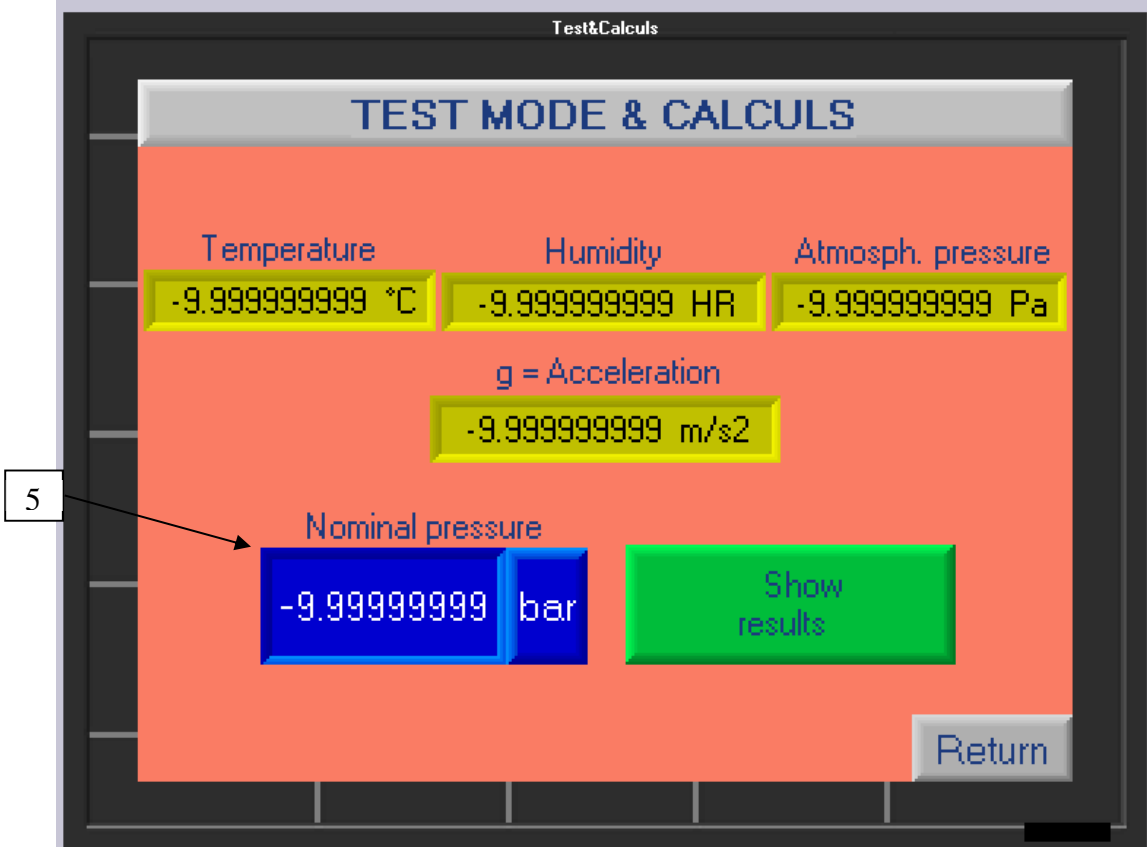

Click on the blue field (5) to enter a pressure value (numeric keypad + validate by pressing the white arrow). Then press the "Show results" button (green button) to go to the next screen.

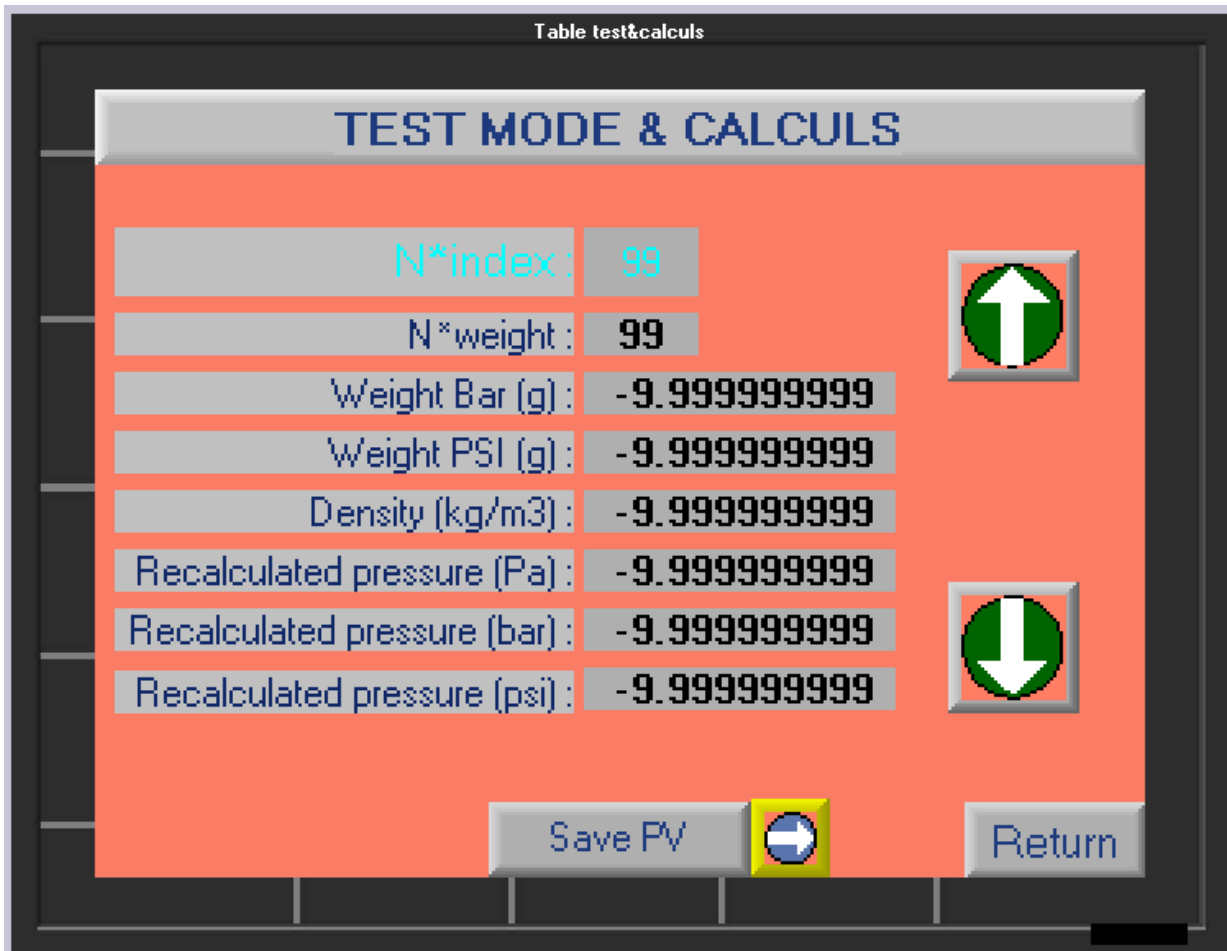

This screen gives you for each weight, the recalculated pressure value in Pa + BAR + PSI, as well as its weight depending on whether the set of weights is in BAR or PSI.

Scroll through the masses using the green arrows.

When finished, click "Return"

e) Special functions (5)

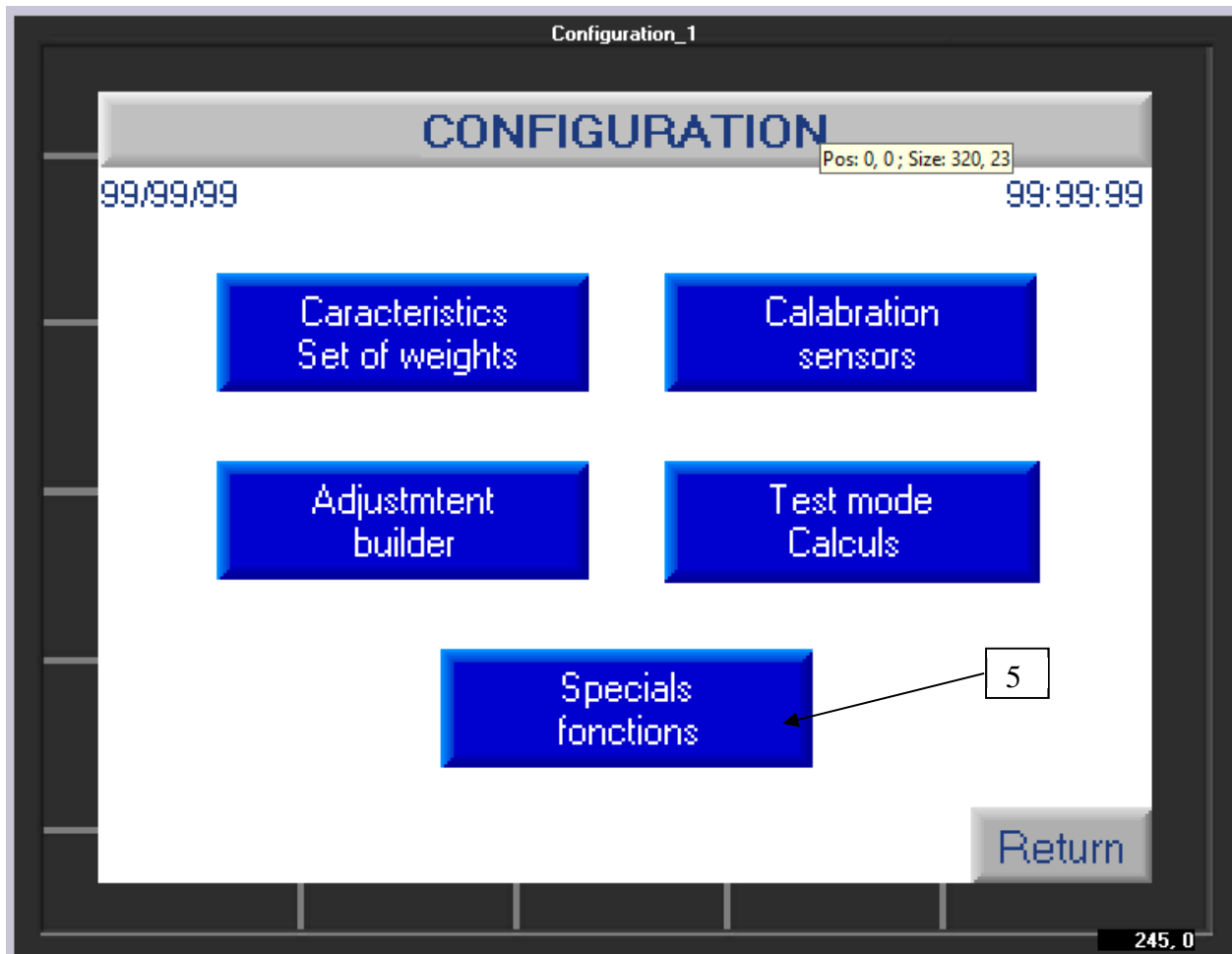

This menu allows you to modify various data such as the date, the time, and the language used by the calculator.

Click on "**Special functions**" (5) + access code **1993** to go to the next screen.

Note: the data entered is not saved permanently. Each time the calculator is started, you must modify its values.

- To modify the date or time fields, click on them and enter the correct value using the numeric keypad that appears.
- To modify the language field: click on it to scroll to the desired language.

Click "**Return**" to exit.

a) Certificate of calibration

➤ AREMECA calibration certificate (manufacturer)

An AREMECA precision certificate is delivered with the DWT. Indeed, we calibrate your device by comparison with our standard dead weight testers. Our standards are controlled by the LNE (French National Laboratory). The certificate that we send you is therefore linked to COFRAC.

Then it is up to the user to define his requirements and to establish the intervals for cleaning, calibration and certification of the device.

> It is recommended that the calibration of the instrument be renewed at regular intervals of 2 to 5 years depending on your frequency of use (approximately every 1000 hours of use).

Note : A dead-weight tester operating on several sites and therefore transported regularly, will require calibration at shorter intervals. Ditto for a DWT with a significant uncertainty. Ditto for a DWT that has not worked for a significant period of time.

➤ COFRAC or DAkkS calibration certificate

A COFRAC or DAkkS type calibration certificate can be issued as an option. Specify when ordering. We can take care of this service !

We keep a copy of the AREMECA or COFRAC certificate in the manufacturing file of your device.

b) Accuracy of the bubble level for BH4

The bubble level to an accuracy of 4mm/m for a deviation of 2mm bubble.

c) Setting the distance sensor

Sensor adjustment is carried out before each use

You can find a small black button behind the sensor.
This button allows you to adjust the detection range of the sensor.

Before starting to adjust it, we must ensure that the dead weight is bass abutment the calculator and the sensor are powered.

Once this is verified you must press 3 seconds the button.

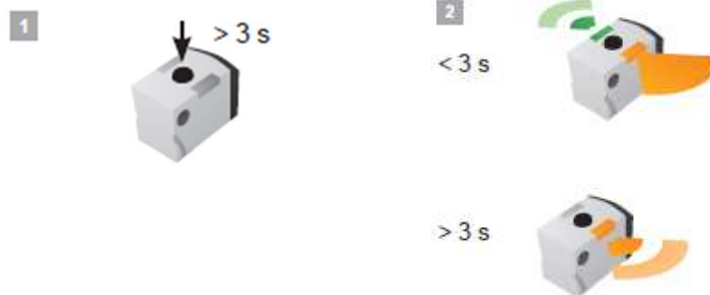

When the orange light flashes you can release the button.



When you release the button, two lights, flash alternately.



Put the dead weight in high abutment (no matter the pressure).
A simple press of the button is enough to confirm that you are in high abutment.



Sensor adjustment and finished.

You can start your measurements.

a) Daily maintenance

Maintaining your scale is very simple and consists of:

- **Clean the compressor** by carrying out a complete purge of your device, rinsing it with the appropriate fluid. (Cf. Chap.3 Commissioning/venting the device)

Note: The instruments under test tend to pollute or even damage your deadweight tester if they are not cleaned before being connected. It is therefore important to maintain your device by carrying out regular maintenance. You will define the frequency of maintenance according to your use. Similarly, when you notice impurities in the tank, it is a good indicator of the quality of your fluid and possible contamination.

- **Check the fluid levels**, particularly in the reservoir. Change the oil if it becomes loaded with impurities, or if it changes viscosity, etc.

Make sure there is enough fluid in the reservoir to perform the required calibrations. If necessary, fill the tank with the same liquid as the one already used. Do not mix different types or brands of liquid in the compressor and use only the recommended oil.

Keep the bench clean, wipe up any spills and pay particular attention to the condition of the oil in the tank to detect traces of pollution.

If the oil in the system is dirty, drain the unit and remove the dirty oil.



*> Option : a cleaning kit (Ref. OP0025)
you will aspire oil and impurities present
in the tank.*

Don't clean the tank with alcohol.

Reminders instructions:

Skydrol, solvents may attack seals mounted on a scale or a standard pressure generator. It is therefore essential to use only the oil supplied with the device. Guarantees of performance and operation are only assured with the use of these oils.



*> Wear eye protection : protects the eyes
against splashes and projections of the
fluid.*

Note : For comparator without valves A', the ability of the pump is 60 cm³ may be insufficient to fill the device to be calibrated with high volume.

In this case, a solution with intermediate valve is possible by interposing it between the generator and the device. The cycle will be repeat as many times as is necessary. For these applications, a specific kit can be supplied. You can also fill in advance, the device to be calibrated before mounting on the generator.

- Do not disassemble the piezometric assembly

It is designed for extremely tight precision limits. It is therefore prohibited to dismantle it. This set represents an important part of the value of the scale, handle it with care and try to keep it clean. In case of deterioration, return the complete assembly for replacement or repair.

The serial number of the piezo assembly is listed on the certificate of accuracy and is listed on the body of the assembly. Mention this number as well as the serial number of the DWT in all correspondence relating to this part.

For DWT, wipe the O-rings under the pressure gauge assembly and the swivel nut adapter. A slight leak through the vent of the piezometric assembly is normal.



*> with the "Small bell" doesn't exceed
Pmax values shown in the table (procedure
BH2-BH3) - Risk of damage to the piston*

- Don't damage the Valves

The bench pressure and DWT are equipped with instrumentation valves, it is essential to comply with the following recommendations:

- maximum torque applicable when the valve is open stop = 0.3 Nm
- maximum torque applicable at closed valve stop = 4 Nm

When the open valve stop is reached, turn the valve wheel 1/4 turn clockwise.

- **Clean its weights** and keep them clean and properly stored. Cleaning can be done with a soft cloth and alcohol.

Each of the weights supplied with the balance is identified by an engraved number.

Store the weights in a storage case and keep them clean. They can be cleaned regularly using a non-abrasive method.



*> Option : suitcase transport and layouts
workstation (Ref.consult us !)*

No additional maintenance should be required if all instructions are followed.

c) Full review

We recommend a complete overhaul of the device every 2 years. This maintenance can only be carried out by our services to maintain the warranty and consists of purging and completely cleaning your device, replacing all seals, replacing missing or defective parts, carrying out leak time tests and of pressure rise. The average response time is 2 weeks

If you wish, we can set up :

- an annual maintenance contract, defining the periodicity, and the criteria of this maintenance. We will take care of managing the periodicity of maintenance.

- one-time maintenance, for this, you must send us your device when you want an intervention. Upon receipt, a complete expertise of your device will be carried out and a repair estimate will be sent to you. We will wait for your order to carry out maintenance or after-sales service.

Note: the manufacturing record of your device is kept with us for the life of the DWT. This traceability allows us

> Options/Accessories/Consumables

a) Options

When ordering a DWT you can choose, a standard or special gravity free of charge, the unit of the main set of weights: BAR, PSI, KPA, Kg/cm² etc... as well as many options.

Our BH2 range are upgradeable, which means that you can add options to your pressure DWT at your leisure in order to gradually optimize your scale and spread your budget.

- **Option OP0004** for the BH2: consists of adding the motorization of the weight set, and the display by LEDs of the position of the piston.

- **The OP0301 option** for the BH2: consists of adding an automaton with sensors, the motorization of the set of weights and the dynamic visualization on a bargraph of the position of the piston.

- **The OP0158 booster pump option:** will allow you to increase the fluid volume of your device by 327cm³. Thanks to this pump, you can fill large volume systems.

b) Connection

We provide you with many accessories to optimize your workstation.

1) For connection

Our devices are equipped as standard with a G1/2 connection. If you need another method of connection, we have several standard fitting cases at your disposal:



- Suitcase with 4 connectors type G (Ref.OP0171)*
- Suitcase with 4 connectors type NPT (Ref.OP0172)*
- Suitcase with 4 connectors type BSPTR (Ref.OP0173)*
- Suitcase with 5 connectors type M (Ref.OP0174)*
- Suitcase with 17 connectors (Ref.OP0037)*

These standard adaptors are designed for pressures below 1250 bar and are also available individually. They are all interchangeable

Note: Each connection set consists of 3 elements:

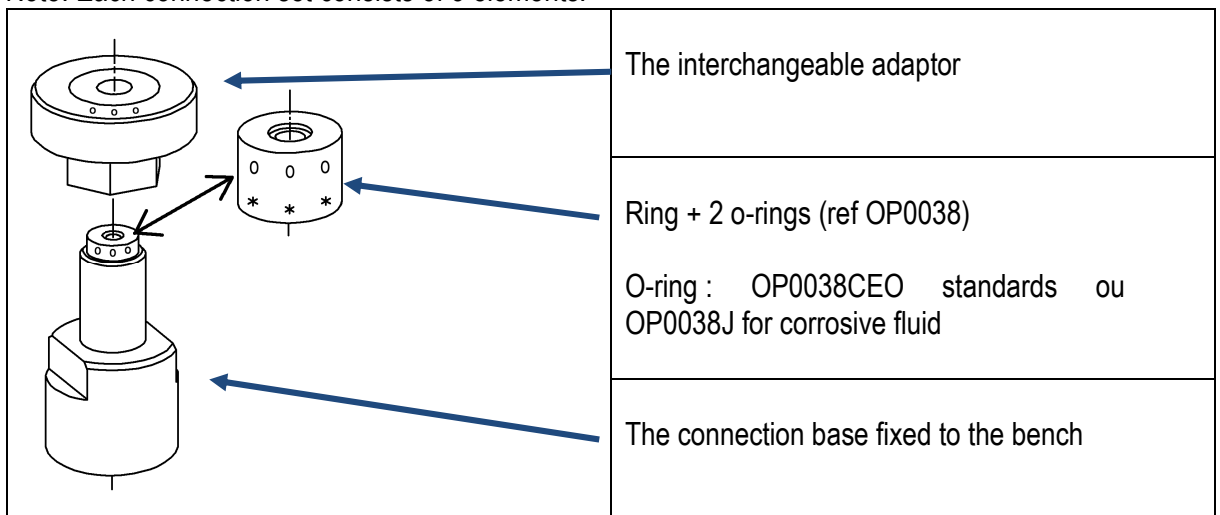

It is necessary to correctly orient the sealing ring according to the type of connection.

Thread M10x100, G1/8, 1/8 BSP-TR, 1/8 NPT

For these connectors guide ring, mark : **000** visible.
The connector must be tightened by hand.

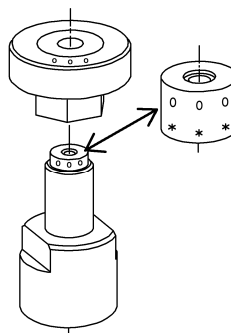

Thread M12x150, M16x150, M18x150, M20x150, G1/4, G3/8, G1/2, 1/4 BSP-TR, 3/8 BSP-TR, 1/2 BSP-TR, 1/4 NPT, 3/8 NPT, 1/2 NPT

For these connectors guide ring, mark : ******* visible.
The connector must be tightened by hand.

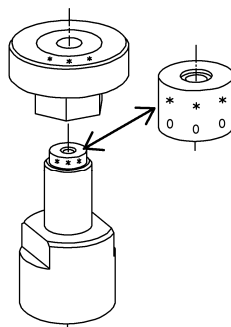

- 2) Cleaning

These accessories are essential tools to preserve your balance over the long term.

OP0025 Tank cleaning pump: sucks oil and impurities from the tank

OP0062 Pressure gauge cleaning bench: allows you to clean and pre-fill your pressure gauge to be checked and avoid soiling your scale

OP0023 Separator for all fluids: prevents contamination of your balance and allows you to work with fluids different from the oil in your pressure gauge to be tested.

- 3) Transportation

Our cases and transport cases will allow you to send your balance to another site or for calibration in complete safety. You will also be able to set up your calibration station and store your weights correctly.

OP0101: Metal transport box for 8 masses

OP009? : Transport case(s) for full weight sets + workstation layout

OP0002: Transport case on wheels for balance or compressor

- 4) Protection of the workstation

If you work in a dirty environment and want to protect your device from dust, our housings are ideal. It is also an additional safety for the operator.

OP0192: Transparent protective casing for non-motorized scale

OP0193: Transparent protective cover for motorized scale

c) Consumables

Our oils are available in 1 liter or 5 liter containers.

OP0014 : 1 liter Oil H40 (models BH2-300B SP to BH2-1200B SP)

OP0135 : 1 liter Oil Sebacate (models BH4)

