

Catalog Pressure AREMECA

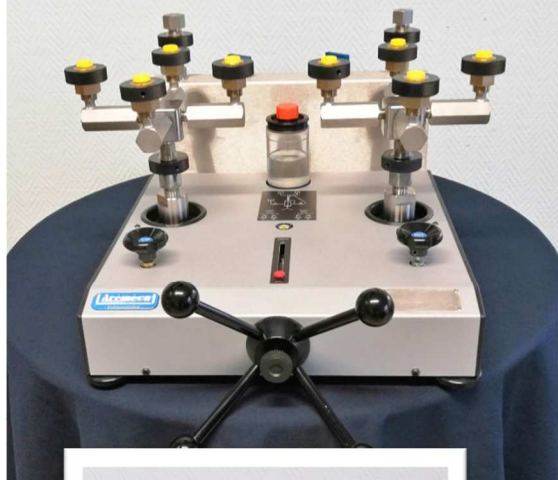

Bespoke manufacture

Range -1 to 10000 bar / 145000 PSI



Accessories / Calibration / Repair



RE.ENR.099 - Ind : K - le 20/02/2023
Pictures are not contractual



address : Zi sud rue Marc Seguin - 41100 VENDOME (France)

Phone Number : +33(0)2.54.80.79.30 - Fax : +33(0)2.54.80.79.31

Web site : www.aremeca-instrumentation.com et www.aremeca.fr

n°TVA intracom : FR 19 349 237 412 - Siret n° : 349 237 412 00029 - Code APE : 2573A

Dead weight testers

Bench comparators

Accessories for pressure

Our company AREMECA, whose headquarters is based in Vendôme (France), distributes these products all over the world through his partners.

We are engaged in manufacturing, controls and testing of our entire pressure range and we put a point in the constant improvement of our products.

Thanks to your loyalty, we have developed new pressure measurement calibration solutions and added new products to the catalog, such as the dead weight tester model BH5-10000B and the pressure bench model CH3-10000B

Anxious to meet your needs: we are currently studying a new range of portable benches and we have started the process of COFRAC accreditation for our laboratory.

Thanks for trusting us !

Contact Marketing & Sales :

Mrs Delphine REGAL
Mail : d.regal@aremeca.fr

Our Website :

www.aremeca-instrumentation.com



Ours ranges of Dead Weight testers

These primary standards are intended to control and calibrate measuring instruments such as pressure gauges or sensors, by comparison with the reference set of weights. Our range is very extensive: from vacuum up to 10000 bar (145000 PSI)

DWT High performance Type BH2 or BA2 Accuracy up to 0.01% rd

Used for regular or intensive calibration.

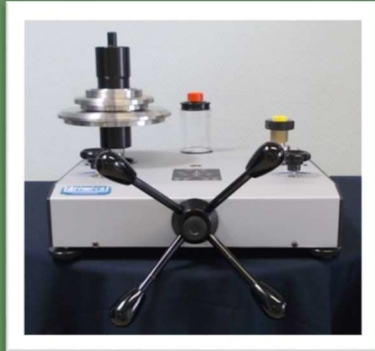

(modèle présenté BH2-150B)

High performance DWT :
Robust design, very mobile, easy to use
Scalable scale by adding options!
Single or double piston versions
Stainless steel masses
Several units available
Adjustment to gravity requested

✓ Hydraulic version (Oil) - Type : BH2

BH2-30B (EM : 0.1 ->30 bar)
 BH2-60B (EM : 0.2 ->60 bar)
 BH2-150B (EM : 0.5 ->150 bar)
 BH2-300B sp* (EM : 1 ->300 bar) BH2-300B dp* (EM : 1 ->300 bar)
 BH2-400B sp* (EM : 1 ->400 bar) BH2-400B dp* (EM : 1 ->400 bar)
 BH2-600B sp* (EM : 2 ->600 bar) BH2-600B dp* (EM : 1 ->600 bar)
 BH2-700B sp* (EM : 2 ->700 bar) BH2-700B dp* (EM : 1 ->700 bar)
 BH2-1200B sp* (EM : 2 ->1200 bar) BH2-1200B dp* (EM : 1 ->1200 bar)
 BH2-2000B (EM : 40 ->2000 bar)
 BH2-2500B (EM : 40 ->2500 bar)
 BH2-3000B (EM : 40 ->3000 bar)
 BH2-4000B (EM : 40 ->4000 bar)
 BH2-5000B (EM : 40 ->5000 bar)
 BH2-6000B (EM : 200 ->6000 bar)
 BH2-7000B (EM : 200 ->7000 bar)
 (SP* = simple piston – DP* = dual piston)

✓ Pneumatic version (Air) – Type : BA2

BA2-1B (EM 15 ->1000 mbar)
 BA2-1VB (EM -15 ->-900 mbar)
 BA2-10B (EM 0.15 ->10 bar)
 BA2-60B (EM 0.5 ->60 bar)
 BA2-120B (EM 1 ->120 bar)
 BA2-200B (EM 2.5 ->200 bar)



Option OP004
 Motorization
 Visualization Leds
 More confort for the
 operateur



Option OP0301
 Motorization + Visualization
 + Sensors + Calculator
 Traceability of calibration data
 Automatic pressure calculation

DWT Automatic Type BH4 or BA4 Accuracy up to 0.005% rd

This product is the indispensable tool for high precision calibration.

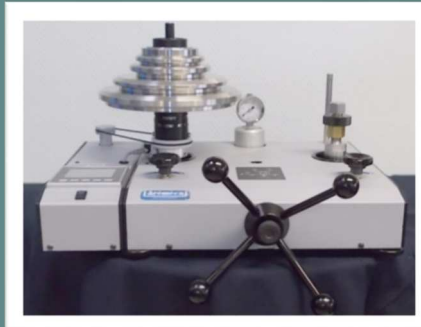

(modèle présenté BA4-200E)

Automatic DWT integrating a calculator :
 Dynamic visualization of the piston position
 Automatic display of the pressure generated by the scale
 Different units of measure with the same set of weights
 Operator assistance during calibration
 Recording of results + transfer to computer
 Stainless steel masses, tungsten/steel piston
 Delivered with the transport case OP0002

✓ H ydraulic version (Oil) - Type : BH4

BH4-30B (EM : 0.1 ->30 bar)
 BH4-60B (EM : 0.2 ->60 bar)
 BH4-120B (EM : 0.5 ->120 bar)
 BH4-300B sp* (EM : 1 ->300 bar)
 BH4-600B sp* (EM : 2 ->600 bar)
 BH4-1200B sp* (EM : 2 ->1200 bar)
 BH4-2000B (EM : 40 ->2000 bar)
 BH4-2500B (EM : 40 ->2500 bar)
 BH4-3000B (EM : 40 ->3000 bar)
 BH4-4000B (EM : 40 ->4000 bar)
 BH4-5000B (EM : 40 ->5000 bar)
 (SP* = simple piston)

✓ Pneumatic version (Air) – Type : BA4

BA4-60B (EM : 0.5 ->60 bar)
 BA4-120B (EM : 1 ->120 bar)
 BA4-200B (EM : 2.5 ->200 bar)

DWT High pressure Type BH5 Accuracy up to 0.05% rd

DWT 10000 bar unique in the world !



(modèle présenté BH5-10000B)

Very high pressure DWT :
 Unique in the world
 Primary standard
 Developed by AREMECA
 10000 bar with 50kg of masses
 Portable compact size

✓ H ydraulic version (Oil) - Type : BH5
 BH5-10000B (EM 200 ->10000 bar)

If you want more information on one of our devices: ask for its technical data sheet!

Or visit our website :

www.aremeca-instrumentation.com

> The + AREMECA

- Commercial and technical monitoring available and responsive,
- A wide range of devices and high-quality accessories,
- Possibility of a complete service offer: Installation, Commissioning etc
- Simple price included: your device, his set of weight and piston / cylinder

But also, benefits without extra ! :

- Your Dead weight designed according to standard gravitation ($g = 9.80665 \text{ m/s}^2$) gravitation (specify when ordering).
- The ability to choose the unit of your standard set of weights (Bar, PSI, Kg / cm²) (range BH2 and BA2).

Differential DWT Types BDH3 or BDA3

- ✓ Hydraulic version (Oil) - Type : BDH3
- ✓ Pneumatic version (Air) - Type : BDA3

Consult us !

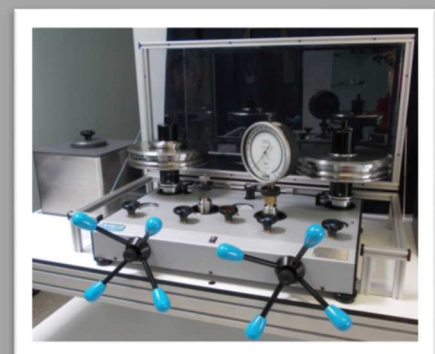

Our ranges of comparison test pumps

The comparison benches are intended for calibration by comparison with a standard manometer. Simple and quick to implement, their design is ergonomic and robust.

Comparison test pumps

Eco and Standards

Types : CEH / CEO / CH1 / CA1



*New range under study !
Suitable for small budgets
For occasional calibrations
Simple and Robust*

✓ **Hydraulic Version (Oil) - Type : CEH or CH1**

CEH-800B (EM 0 ->800 bar)
CEH-1250B (EM 0 ->1250 bar)
CH1-125B (EM 0 ->125 bar)
CH1-1250B (EM 0 ->1250 bar)

✓ **Hydraulic Version (Water) - Type : CEO**

CEO-700B (EM 0 ->700 bar)

✓ **Pneumatic Version (Air) - Type : CA1**

CA1-200B (EM 0 ->200 bar)

Comparison test pumps

High Performance

Types : CH2 / CO / CA2



*Can evolve into pressure balance
Reliable and Robust
For regular calibrations
Many options*

✓ **Hydraulic Version (Oil) - Type : CH2**

CH2-125B (EM 0 ->125 bar)
CH2-1250B (EM 0 ->1250 bar)
CH2-2000B (EM 0 ->2000 bar)
CH2-4000B (EM 0 ->4000 bar)
CH2-7000B (EM 0 ->7000 bar)

✓ **Hydraulic Version (Water) - Type : CO**

CO-800B (EM 0 ->800 bar)
CO-1000B (EM 0 ->1000 bar)

✓ **Pneumatic Version (Air) - Type : CA2**

CA2-200B (EM 0 ->200 bar)

Upgrade your comparison bench to a DWT :



Buy the PCU + set of weights
Your CH2 -> DWT type BH2
Or your CA2 -> DWT type BA2
Consult us !

Comparison test pumps

High Pressure

Type : CH3



Comparison bench unique in the world

This pressure standard is the only calibration device on the market that is capable of generating 10000 bar of pressure.

✓ **Hydraulic Version (Oil) - Type : CH3**

CH3-10000B (EM 0 ->10000 bar)

Comparison test pumps

Portable

Types : CAA

*Autonomous and light
Integrated in a transport case*

✓ **Pneumatic Version (Air) - Type : CAA**

CAA-20B (EM -0.9 ->20 bar)

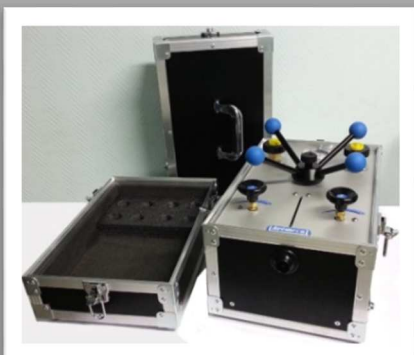

Complete your comparison bench with: our fitting cases, our standard pressure gauges, our calibration ramps, our transport cases, etc.

ADAPTORS

Standards (<1200 bar), High pressure (from 1200 bar to 10000 bar) or tailor-made
They will allow you to connect your instrument to the standard.

➤ ADAPTATORS STANDARDS (P < 1200 bar)



- ✓ ref **OP0174** : suitcase with 5 metrics adaptors
Contains : M10 x 100 ; M12 x 150 ; M16 x 150 ; M18 x 150 ; M20 x 150
- ✓ ref **OP0171** : suitcase with 4 Gas cylindrical adaptors
Contains : G1/8 ; G1/4 ; G3/8 ; G1/2

Conical adaptors up to 1200 bar

- ✓ ref **OP0172** : suitcase with 4 adaptors NPT
Contains : 1/8 NPT ; 1/4 NPT ; 3/8 NPT ; 1/2 NPT
- ✓ ref **OP0173** : suitcase with 4 adaptors BSP-TR
Contains : 1/8 BSP-TR ; 1/4 BSP-TR ; 3/8 BSP-TR ; 1/2 BSP-TR



- ✓ ref **OP0037** : suitcase with 17 standards adaptors (1200 bar max) :
 - Cylindrical adaptors : M10 x 100 ; M12 x 150 ; M16 x 150 ; M18 x 150 ; M20 x 150 ; G1/8 ; G1/4 ; G3/8 ; G1/2
 - Conical adaptors : 1/8 NPT ; 1/4 NPT ; 3/8 NPT ; 1/2 NPT ; 1/8 BSP-TR ; 1/4 BSP-TR ; 3/8 BSP-TR ; 1/2 BSP-TR



- ✓ ref **OP0057** : Suitcase with tools
 - 1 set of adaptors : 1/2 and 1/4 gas ; 1/2 and 1/4 NPT
 - + 90° elbow union
 - +1 flat spanner
 - +1 assembly for assembly / disassembly of needles
 - +1 hammer

➤ ADAPTORS HIGH PRESSURE (P>1200 bar)



High pressure adaptors HP and HP+

- ✓ ref **OP0220** : suitcase with 5 adaptors HP in M16x150
(For range CH2 or BH2 : 2000B<P<10000 bar) Pmax= 7000 bar except G1/2 = 2500 bar
with M16x150HP M - G1/2F ; M16x150HP M/M ; M16x150HP M - M20x150HP M ; M16x150HP M - 9/16" 18UNF M ; M16x150HP M - 9/16" 18UNF F ; plug M16x150HP

- ✓ ref **OP0250** : suitcase with 5 adaptors HP+ in M20x150
(For range CH3 or BH5 = 10000 bar) Pmax = 10000 bar for * , other 7000 Bar except G1/2 =2500 Bar
With adaptors : M20x150HP+ M - G1/2F ; M20x150HP+ M/M* ; M20x150HP+ M - M16x150HP M ; M20x150HP+ M - 9/16" 18UNF M ; M20x150HP+ M - 9/16" 18UNF F ; plug M20x150HP+*









➤ ADPATORS TAILOR-MADE









- ✓ Adaptor tailor-made or unit price
All standards adaptors are available individually – Ability adaptors specifics request, please contact us.

PRESSURE GAUGES : bourdon tube - digitals

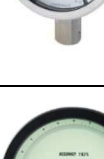
Used as a reference with our comparison test pumps

Référence Produit (Models)	DIGITAL
	ADT681 : accuracy 0,05% of l'EM - température -10 to 50°C - Ø110mm x 85mm
	ADT681b : accuracy 0,025% of l'EM - température -10 to 50°C - Ø110mm x 85mm
	ADT673 : accuracy 0,05% of l'EM (0,1% of l'EM for models >1000B) - température -10 to 50°C - Ø120mm x 46mm
	XP2i : accuracy 0,1% of l'EM - température -10 to 50°C - Ø114mm x 36mm - Connexion G1/2
	BARFLEX : accuracy 0,1% of l'EM - température -20 to 85°C - 98mm x64mm x35mm - Connexion G1/2
	CRP101 : accuracy 0,05% of l'EM - température -10 to 70°C - Ø129mm
	LABDMM : accuracy 0,05% of l'EM - température -10 to 60°C - 85x85mm x 44mm
	IDRO : accuracy 0,2% of l'EM - température -10 to 70°C - Ø80mm

Référence Produit (Models)	WITH BOURDON TUBE
	MEX5 : accuracy 1% - température -20 to 70°C - Ø100mm x 50mm
	MIX7 : accuracy 1% - température -20 to 70°C - Ø150mm x 54mm
	222A : accuracy 1% - Ø100mm or ~150mm - Connexion M16x1,5
	MN17 : accuracy 0,1% - Ø250mm x 63mm- Connexion G1/2
	MN17 : accuracy 0,25% - Ø250mm x 63mm - Connexion G1/2
	171A : accuracy 0,25% - Ø150mm - Connexion G1/2

Note : Complete your comparison bench with our reference pressure gauges. This list is likely to evolve, don't hesitate to contact us!



OP0194 : fine adjustment valve for comparison bench. It allows you to refine your measurements !



✓ Control blocs for pressure gauges
OP0195 for 2 pressure gauge
OP0302 for 3 pressure gauge
OP0303 for 4 pressure gauge



✓ Ramps for pressure gauges
OP0304 Ramp for 2 pressure gauge
OP0305 Ramp for 3 pressure gauge

Positioned on the G1/2 adaptors of your comparison bench or your DWT

ACCESSORIES for Pressure gauges

Essential tools for doing adjustment operations on pressure gauges with bourdon tube



Eco prix !

✓ ADJUSTMENT TOOLS FOR PRESSURE GAUGE

OP0228 Suitcase with 3 needles up and pear

Used to remove the needles of manometers during repairs or adjustments, as well as to fix the needles on the axis of the devices. This case is composed of three needle removers with different diameters ($\text{Ø}0.8 + \text{Ø}1.0 + \text{Ø}1.2$) You simply have to insert it below the needle of the manometer to be able to remove it. The equipment also includes a pressure gauge needle driver, consisting of a stainless steel cylinder ($180 \times 10 \text{ mm. } \text{Ø}$) attached to a silicone tube and a rubber bulb. A steel ball is located inside the cylinder and hits the needle when the rubber bulb is pressed. Everything is supplied in a carrying case.

✓ Accessories individually:

OP0222 Pear for pressure gauge

OP0223 $\text{Ø}0.8$ or pressure gauge $\text{Ø}40$ to 63

OP0224 $\text{Ø}1.0$ for pressure gauge $\text{Ø}100$ to 160

OP0225 $\text{Ø}1.2$ for pressure gauge duplex

✓ Economical version :

OP0125 Kit eco for pressure gauge

Eco suitcase with one Needle up (you can choose **OP0223** $\text{Ø}0.8$ or **OP0224** $\text{Ø}1.0$)
+ hammer to engage the needle of the pressure gauge



✓ GAUGE HOUSING REMOVAL PLIERS

Different models depending on the size of your pressure gauge

OP0226 for pressure gauge $\text{Ø}100$

OP0227 for pressure gauge $\text{Ø}150$

OP0255 for pressure gauge $\text{Ø}63$



✓ STABILIZATION FOOT for PRESSURE GAUGES

This accessory connects very quickly to a hand pump.

Its wide foot provides stability and comfort of use. You keep your hands free and secure your manometer. Small in size, it is easy to transport.

There are two models :

OP0180 without hose provided for Pressure up to 1200 Bar

OP0182 with $1/8$ conical gas outlet hose for pressures up to 600 bar .

CLEANING ACCESSORIES

They facilitate purge operations during preventive maintenance, allow you to clean or isolate pressure gauges before connection to your standard. This will protect your standard against contamination or corrosive fluids.



The +: The tool
much appreciated
by our customers

✓ **OP0062** Cleaning bench for pressure gauge

✓ **Description**

This bench has been designed to prepare the instruments to be calibrated (cleaning, filling) before connection. The use of this bench will reduce significantly the risk of contamination of comparison test pumps and dead weight testers.

This preparation bench is not suitable for any vacuum instruments.



✓ **OP0025** drain kit for oil tank

✓ **Description**

The drain kit is useful to draw deposits and contaminated oils in your tank. This hand pump can quickly and easily clean your device



✓ **OP0023** Separator liquid/liquid

✓ **Description**

The separator has several advantages :

- avoids cleaning the pressure gauge which must be checked isolating it from the calibrator
- avoids the contamination of your calibrator
- prevents the fluids contained in the manometer and the calibration bench from mixing ; a pressure gauge with water or corrosive fluid can be calibrated with oil calibrator without damaging it

Technical data :

- use up to 800 bar
 - volume 120ml
 - the membranes resist most corrosive fluids
- OP236-319 material Butyl
OP236-320 material Viton

POMPES de gavage

Elles peuvent être raccordées à nos bancs pour obtenir un volume d'huile de gavage plus important.



Tank pump

- ✓ **OP0158** Reservoir pump (volume 327 cm³) until 700 bar

✓ Description

The reservoir pump OP0158 is an essential accessory to increase the volume of oil useful for calibration of your device. Design ultra light weight and compact, with a reservoir filled nylon fiberglass and aluminum, this reservoir pump offers maximum resistance to corrosion and can contain a large oil capacity : 327 cm³. Maximum pressure 700 bar. It should be use with the comparison test pump.

Practical and ergonomic, it requires a little effort of pumping under the lever providing less fatigue for the user.

Other models available on request – Consult us !

Hand PUMP

Easy to transport, our range extends up to 700 bar.



Pompes à mains

- ✓ Hand pumps pneumatics and hydraulics

PM-60B -> -0.95 à 60 bar

✓ Description

The hand pump PM is a simple tool that allows fast and robust verification of your pressure gauge etc..

Other models available on request – Consult us !

COVERS

Ergonomic and very practical to protect your device



- ✓ Cover for dead weight testers or comparison test pump
OP0192 (without motorization) or OP0193 (with motorization)

✓ Description

Ideal to realize test points in a stable environment and protect your device. This cover also allows to assure the safety of your operator.

TRANSPORT ACCESSORIES

Our carrying suitcases have been designed to ship our products in complete safety : comparison test pumps, dead weight testers, sets of weights, etc.

> CASE FOR THE TRANSPORT OF WEIGHTS



Eco price !

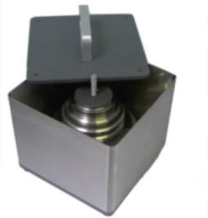

OP0101 : Metal Box for set of weights - Model ECO

✓ Description

This box metal allows shipping easily your set of weights. Dimensions reduce, sober design, this arrangement is completely adapted to tidy up and protect your weights

-> 7 weights / metal box

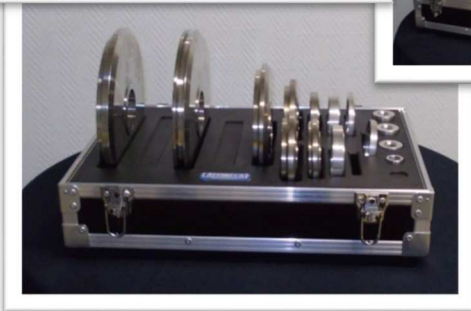
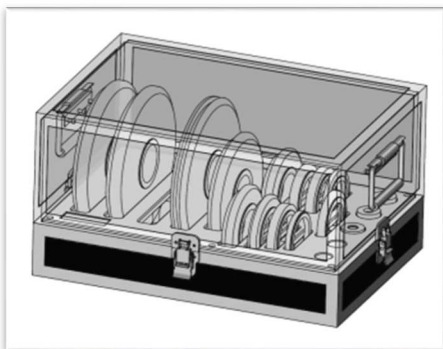

OPxxxx (variable reference depending on device)

Suitcase for shipping set of weights and ergonomic workstation

✓ Description

These suitcases of modern and strong finishes were designed to optimize your user-friendliness.

Indeed, they serve on one hand to transport in complete safety your weighty, which is orderly vertically, isolating every weight so avoiding any friction or stripe during the shipping.

But the real key point is at the level of the bottom of the suitcase, because he allows the user to place set of weight at adequate height and to fit out very quickly his workstation. This ergonomics : facilitate the access and the grip of the masses, limits their handling, allows a visual control of the masses

> CASE FOR CALIBRATION BENCH



OP0029 : Suitcase for the transport of comparison test pump type CEH ou CEO

✓ Description

Ideal to transport your device in complete safety



OP0002 : Suitcase for transport dead weight tester or comparison test pump (except models BH5 and CH3)

✓ Description

Ideal to transport your dead weight or comparison test pump in complete safety.

Diagramme des accessoires de nos Balances manométriques

(Accessories's diagram for our Dead weight testers)

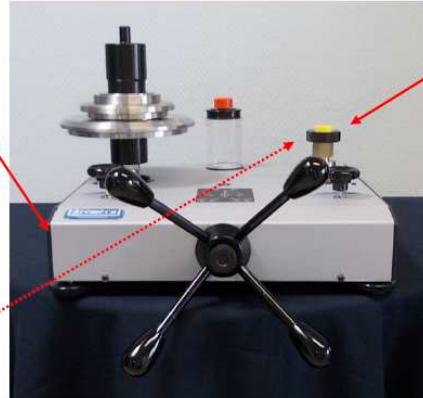

Balances manométriques Gamme BH2 ou BA2
(dead weight testers Range BH2 or BA2)

Ajouter de la fonctionnalité
(Add functionality)



OP0004 motorisation/visualisation
Leds
(Motorization/visualization LCD)



OP0301 automate de calcul
(calculator)

Raccords de connexion (Adaptors)



OP0037 mallette 17 raccords
(Suitcase with 17 adaptors)

Accessoires divers
(Optional accessories)



OP0023 séparateur liquide/liquide
(separator liquid/liquid only)



OP0194 réglage fin (adjust value)



OP236-908 sortie au dos
(horizontal adapter)

Rampe de contrôle manomètres
(Ramp for pressure gauges)



Rampe (Ramp) OP0305 ou OP0304



Bloc OP0303

Diagramme des accessoires de nos bancs de comparaison

(Accessories's diagram for our comparison test pumps)

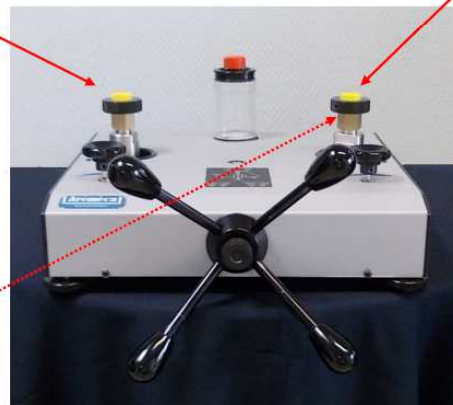

Banc de Comparaison Gamme CH2 ou CA2
(Comparison pump Range CH2 or CA2)

Kit balance manométrique
(dead weight kit)



Instrument de référence
(the reference)



Manomètres à aiguille
Pressure gauges with bourdon
tube



Manomètres numériques
Digitals Pressure gauges

Raccords de connexion (Adaptors)



OP0037 mallette 17 raccords
(Suitcase with 17 adaptors)

Accessoires divers
(Optional accessories)



OP0023 séparateur liquide/liquide
(separator liquid/liquid)



OP0194 réglage fin (adjust value)



OP236-908 sortie au dos
(horizontal adapter)

Rampe de contrôle manomètres
(Ramp for pressure gauges)



Rampe (Ramp) OP0305 ou OP0304



Bloc OP0303

OUR SERVICES

SERVICE AFTER SALES all marks



Our technical department has a know-how of more than 30 years. We put our expertise at your service to support your device in a reactive time.

*Send your equipment to : AREMECA - Zi Sud Rue Marc Seguin - 41100 VENDOME
Accompanied by your contact information and a description of the problem.*



Our technicians are at your disposal to carry out the preventive maintenance of your device, but also to intervene on the repair or on the resolution of technical problems that you may encounter.

Upon receipt of your device, a complete expertise and tests will be carried out in order to establish a detailed estimate. Upon receipt of your agreement, the repair will be scheduled. In case of impossibility of repair, or too high costs, we will recommend a replacement device.

- **Preventive maintenance** includes : complete cleaning, replacement of seals, pressure tests.
- **Repair** includes : cleaning, replacement of broken parts, replacement of seals, pressure tests

We ensure the traceability of our interventions throughout the life of the device.

For AREMECA products, data relating to assembly, manufacturing and after-sales service are kept under its serial number. For other brands, we keep the data under their identification number.

Our sales department is at your disposal to plan an intervention.

CALIBRATION : Transmitter, Pressure gauge, Dead weight testers

Our reference Oil DWT

- * Etalon / standard : **H0001** -> BH2-1200B
Uncertainty of the pressure measured (in bar) :
 $\pm 5.2 \times 10^{-3} + (9.5 \times 10^{-5} \times P)$ with P in bar
- * Etalon / standard : **H0002** -> BH3-60B
Uncertainty of the pressure measured (in bar) :
 $\pm 5.5 \times 10^{-4} + (7.3 \times 10^{-5} \times P)$ with P in bar
- * Etalon / standard : **1235** -> BH3-5000B
Uncertainty of the pressure measured (in bar) :
 $\pm 1.4 \times 10^{-2} + (1.2 \times 10^{-4} \times P)$ with P in bar

Our reference Air DWT

- * Etalon / standard : **A0004** -> BA3-10B
Uncertainty of the pressure measured (in bar) ::
 $\pm 9 \times 10^{-5} + (8 \times 10^{-5} \times P)$ with P in bar
- * Etalon / standard : **A0007** -> BA4-200B
Uncertainty of the pressure measured (in bar) ::
 $\pm 2.3 \times 10^{-4} + (6.5 \times 10^{-5} \times P)$ with P in bar

A service control point or calibration COFRAC or DaKKs / DKD may also be performed on dead weight testers

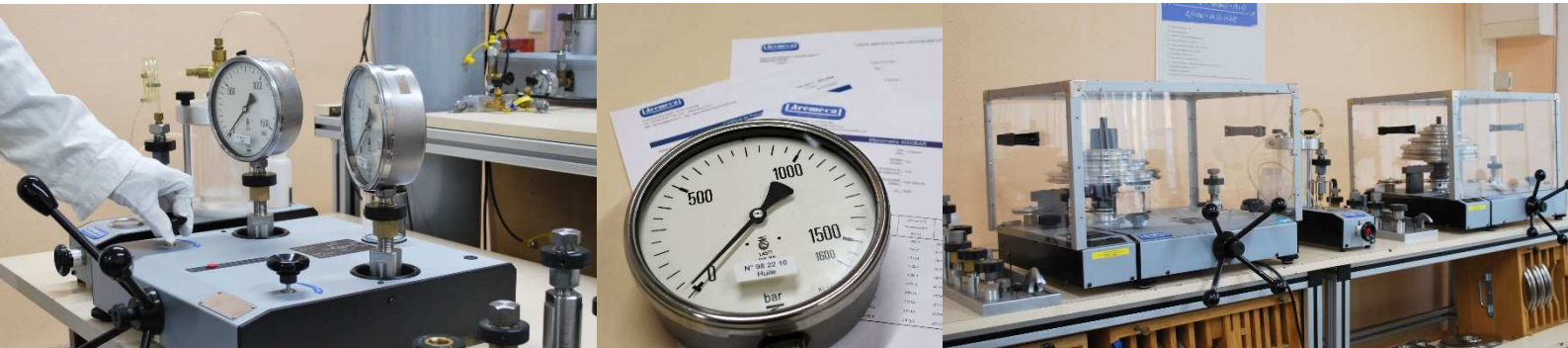

- CALIBRATION LABORATORY in an AIR-CONDITIONED ROOM -

Our measurement laboratory offers you a calibration service of up to 5000 bar traceable to national standards (COFRAC connected).

> Upon receipt of your equipment, we will carry out an initial expertise :

Allocation of an intervention number (Traceability / Working condition / Feasibility of connections / etc..)

>Laboratory storage :

Warming up your instrument before calibration

>Calibration of the instrument :

Realization of measurement points (10 or 20 points on the main measurement range)

Results analysis

Edition of the Point statement, and notification of any observations

>Shipping :

Your instrument will be returned in its original packaging accompanied by its certificate.



DESIGN / DEVELOPMENT of your workstation

Our design office works regularly with all types of industries: AUTOMOTIVE, AERONAUTICS, PETROCHEMICALS, RAILWAYS, PHARMACEUTICALS, COSMETICS, FOOD, ENERGY etc...

We can design and build your workstation to meet your needs. Our team will work according to your specifications.

Don't hesitate to submit your problem to us, we will find a solution together! Many customers have trusted us, here are some examples :

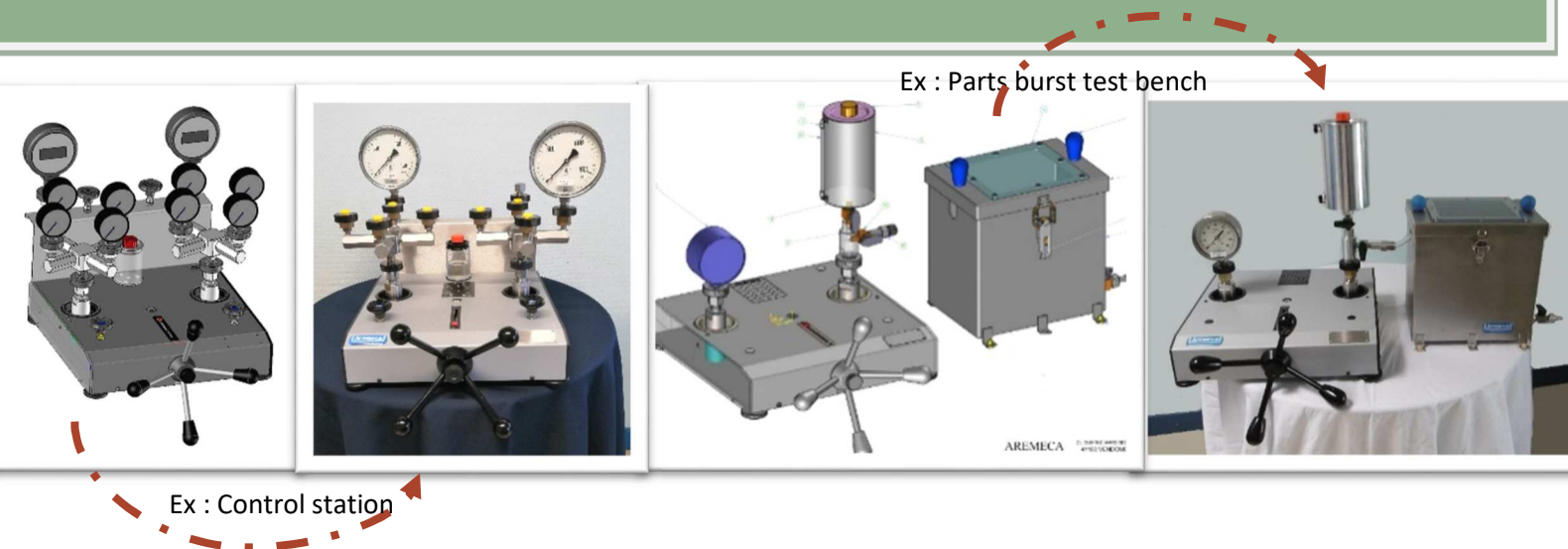

Expert in pressure metrology, we can custom manufacture your control station

Submit your problem to us, and our teams: Design and Technical Office will study your specifications in order to offer you a solution. We can model a pre-project, send you the first technical elements, etc.

As a manufacturer, we can modify one of our products so that it best meets what you are looking for or develop a new solution that can even integrate our product catalog.

We have already designed accessories for our customers: pressure gauge cleaning bench, pressure gauge ramp, etc. But also complete control stations with workbench and transport case.

We remain at your disposal, don't hesitate !



Our partners : Our products are sold all over the world thanks to our distributors

EUROPA



AFRICA



ASIA



NORTH AMERICA



SOUTH AMERICA



OCEANIA



To obtain the coordinates of the distributor closest to you - Contact us !

1/2 siècle de savoir faire

EM : 1 000 bar
Précision 1.10^{-3}

EM : 10 000 bar
Précision 5.10^{-5}

✓ Une Fiabilité éprouvée	✓ La Garantie	✓ Votre référence Française
> Sur le marché mondial depuis de nombreuses années, nos produits sont reconnus pour leur longévité et leur stabilité	> Des services commercial, technique et SAV réactifs > Des produits garantis 2 ans	> Nos appareils d'étalonnage de pression peuvent être certifiés DKD/Dakks ou COFRAC > Nos précisions vont jusqu'à 5.10^{-5}

Our primary objective is to provide excellent service, which is why we select our partners carefully.

Our requirements :

Proximity : to be able to meet with you on your site and better serve you, our specialists are near you !

Technical knowledge : to understand your needs, take into account your technical requirements, offer the best solution partners are real specialist pressure instruments.

Quality / Service : We our utmost to ensure that our products are recognized for their quality and reliability. Listening to our customers, standards, the instrumentation market, we regularly up actions of research and development to optimize our products but also offer you new products offering new possibilities.

This is why it is important that our partners also offer you the best service. They can assist you in defining the specifications, in the selection of products in the installation / implementation, training of your technicians etc .. They also send us your comments, suggestions about our products and allow us to consider your expectations on the development of our range.

Reactivity : the relationship we have with our partners is a trust and lasting relationship. We support on technical issues, they offer many marketing and sales support, because we want them to be responsive and accurate in their technical solutions.

If you want to become a partner, contact us !

NOTE

NOTE



Marketing & Sales Manager to international : Delphine REGAL

Mail : d.regal@aremeca.fr

Technical Manager : Frédéric MOUTARDIER

Mail : f.moutardier@aremeca.fr